

CHEMISTRY FORM 1 NOTES

WhatsApp/Sms/Call 0706 851 439



By SIR OBIERO AMOS
RESOURCES

&



AMOBİ SOFT COPY PUBLISHERS

Transparency, Honesty and Accountability Defined

 The Best Ahead of The Rest

 Tested, Tried & Trusted

 Wholly Published By Amobi Soft
Copy Publishers & Distributed By Sir
Obiero Amos 0706 851 439

Amobi Soft Copy Publishers & By Sir
Obiero Amos Resources

Thank you for your trust.

WhatsApp/Sms/Call us on:
0706 851 439

Email us on:
amosobiero7@gmail.com

Introduction to chemistry

Chemistry is a branch of Science. Science is basically the study of living and non-living things. The branch of science that study living things is called Biology. The branch of science that study non-living things is called Physical Science. Physical Science is made up of:

- (i) Physics- the study of matter in relation to energy
- (ii) Chemistry- the study of composition of matter.

Chemistry is thus defined as the branch of science that deals with the structure composition, properties and behavior of matter.

Basic Chemistry involves studying:

(a) States/phases of matter

Matter is anything that has weight/**mass** and occupies space/**volume**. Naturally, there are basically **three** states of matter.

(i) **Solid**-e.g. soil, sand, copper metal ,bucket, ice.

(ii) **Liquid**-e.g water, Petrol, ethanol/alcohol, Mercury(liquid metal).

(iii) **gas**- e.g. Oxygen, Nitrogen ,Water vapour.

A solid is made up of particles which are very closely packed. It thus has a definite/fixed shape and fixed/definite volume /occupies definite space. It has a very high density.

A liquid is made up of particles which have some degree of freedom. It thus has no definite/fixed shape. It takes the shape of the container it is put. A liquid has fixed/definite volume/occupies definite space.

A gas is made up of particles free from each other. It thus has no definite/fixed shape. It takes the shape of the container it is put. It has no fixed/definite volume/occupies every space in a container.

FOR: Form 2, 3 & 4 NOTES, latest & Updated Schemes of Work, Quality Revision Booklets, Entry, Mid-Term& End-Term Exams, All KASNEB notes, Set-Books Acted Videos.....

WhatsApp Sir Obiero Amos @ 0706 851 439



(b) Separation of mixture

A mixture is a combination of two or more substances that can be separated by physical means. Simple methods of separating mixtures at basic chemistry level include

(i)**Sorting/picking**-this involve physically picking one pure substance from a mixture with another/other. e. g. sorting maize from maize beans mixture.

(ii)**Decantation**-this involve pouring out a liquid from a solid that has settled /sinking solid in it. e. g. Decanting water form sand .

(iii)**Filtration**-this involves sieving /passing particles of a mixture through a filter containing small holes that allow smaller particle to pass through but do not allow bigger particle to pass through.

(iv)**Skimming**-this involve scooping floating particles. e.g. cream from milk

(c) Metals and non-metals

Metals are shiny, ductile(able to form wires),malleable(able to form sheet) and coil without breaking. e.g. Iron, gold, silver, copper. Mercury is the only **liquid metal** known.

Non-metals are dull, not ductile(do not form wires), not malleable(do not form sheet) and break on coiling/brittle. e.g. Charcoal, Sulphur , plastics.

(d) Conductors and non-conductors

A conductor is a solid that allow electric current to pass through. A non-conductor is a solid that do not allow electric current to pass through.

All metals conduct electricity. All non-metals do not conduct electricity except carbon **graphite**.

(e)Drugs



A drug is a natural or synthetic/man-made substance that when taken changes/alter the body functioning. A natural or synthetic/man-made substance that when taken changes/alter the abnormal body functioning to normal is called **medicine**. Medicines are thus drugs intended to correct abnormal body functions. . Medicines should therefore be taken on **prescription** and **dosage**.

A prescription is a medical instruction to a patient/sick on the correct type of medicine to take and period/time between one intake to the other .

A dosage is the correct quantity of drug required to alter the abnormal body function back to normal. This is called **treatment**.

It is the professional work of qualified doctors/pharmacists to administer correct prescription and dosage of drugs/medicine to the sick.

Prescription and dosage of drugs/medicine to the sick use medical language.

Example

(i) **2 x 4** ; means “**2**” tablets for **solid** drugs/spoon fulls for **liquid** drugs taken “**4**” times for a duration of one day/24 hours and then repeated and continued until all the drug given is finished.

(ii) **1 x 2** ; means “**1**” tablets for **solid** drugs/spoon fulls for **liquid** drugs taken “**2**” times for a duration of one day/24 hours and then repeated and continued until all the drug given is finished.

(iii)

Some drugs need minimal prescription and thus are available without pharmacist/doctor’s prescription. They are called **Over The Counter(OTC)** drugs. OTC drugs used to treat mild headaches, stomach upsets, common cold include:

(i) painkillers

(ii) anti acids

(iii) cold/flu drugs.

All medicines require correct intake dosage. When a prescription dosage is not followed, this is called drug **misuse/abuse**.



Some drugs are used for other purposes other than that intended. This is called **drug abuse**.

Drug abuse is when a drug is intentionally used to alter the normal functioning of the body. The intentional abnormal function of the drug is to make the victim have false feeling of well being.

The victim lack both mental and physical coordination.

Some drugs that induce a false feeling of well being are illegal. They include heroin, cocaine, bhang, mandrax and morphine.

Some abused drugs which are not illegal include: miraa, alcohol, tobacco, sleeping pills.

The role of chemistry in society

(a)Chemistry is used in the following:

(i)Washing/cleaning with soap:

Washing/cleaning is a chemical process that involve jnteraction of water,soap and dirt so as to remove the dirt from a garment.

(ii)Understanding chemicals of life

Living thing grow, respire and feed. The formation and growth of cells involve chemical processes in living things using carbohydrates, proteins and vitamins.

(iii)Baking:

Adding baking powder to dough and then heating in an oven involves interactions that require understanding of chemistry.



(iv)Medicine:

Discovery, test ,prescription and dosage of drugs to be used for medicinal purposes require advanced understanding of chemistry

(v)Fractional distillation of crude oil:

Crude oil is fractional distilled to useful portions like petrol,diesel,kerosene by applying chemistry.

(vi)Manufacture of synthetic compounds/substances

Large amounts of plastics, glass, fertilizers, insecticides, soaps, cements, are manufactured worldwide. Advanced understanding of the chemical processes involved is a requirement.

(vii)Diagnosis/test for abnormal body functions.

If the body is not functioning normally,it is said to be sick/ill.Laboaratory test are done to diagnose the illness/sickness.

(b)The following career fields require Chemistry as one of subject areas of advanced/specialized study:

- (i)Chemical engineering/chemical engineer
- (ii)Veterinary medicine/Veterinary doctor
- (iii)Medicine/Medical doctor/pharmacist/nurse
- (iv)Beauty/Beautician
- (v)Teaching/Chemistry teacher.

The School Chemistry Laboratory

Chemistry is studied mainly in a science room called a school chemistry **laboratory**. The room is better ventilated than normal classroom. It has electricity, gas and water **taps**.

A school chemistry laboratory has a qualified professional whose called Laboratory technician/assistant.



All students user in a school chemistry laboratory must consult the Laboratory technician/assistant for all their laboratory work.

A school chemistry laboratory has chemicals and apparatus.

A chemical is a substance whose composition is known. All chemical are thus labeled as they are.

This is because whereas physically a substance may appear similar, chemically they may be different.

All Chemicals which are not labeled should never be use.

Some chemicals are toxic/poisonous, explosive, corrosive, caustic, irritants, flammable, oxidizing, carcinogenic, or radioactive.

Care should always be taken when handling any chemical which have any of the above characteristic properties.

Common school chemistry laboratory chemicals include:

- (i)distilled water
- (ii)Concentrated mineral acid which are very corrosive(on contact with skin they cause painful open wounds)
- (iii)Concentrated alkali/bases which are caustic(on contact with skin they cause painful blisters)
- (iv)Very many types of salts

The following safety guideline rules should be followed by chemistry laboratory users:

(i)Enter the laboratory with permission in an orderly manner without rushing/pushing/scrabbling.

(ii)Do not try unauthorized experiments. They may produce flammable, explosive or toxic substances that affect your health.

(iii)Do not taste any chemical in the laboratory. They may be poisonous.



(iv) Waft gas fumes to your nose with your palm. Do not inhale/smell gases directly. They may be highly poisonous/toxic.

(v) Boil substances with mouth of the test tube facing away from others and yourself. Boiling liquids spurt out portions of the hot liquid. Products of heating solids may be a highly poisonous/toxic gas.

(vi) Wash with lots of water any skin contact with chemicals immediately. Report immediately to teacher/laboratory technician any irritation, cut, burn, bruise or feelings arising from laboratory work.

(vii) Read and follow safety instruction. All experiments that evolve/produce poisonous gases should be done in the open or in a fume chamber.

(viii) Clean your laboratory work station after use. Wash your hand before leaving the chemistry laboratory.

(ix) In case of fire, remain calm, switch off the source of fuel-gas tap. Leave the laboratory through the emergency door. Use fire extinguishers near the chemistry laboratory to put out medium fires. Leave strong fires wholly to professional fire fighters.

(x) Do not carry unauthorized item from a chemistry laboratory.

An apparatus /apparatus are scientific tools/equipment used in performing scientific experiments. The conventional apparatus used in performing a scientific experiment is called **standard** apparatus. If the conventional standard apparatus is not available, an **improvised** apparatus may be used in performing a scientific experiment. An improvised apparatus is one used in performing a scientific experiment **for** a standard apparatus. Most standard apparatus in a school chemistry laboratory are made of **glass** because:

(i) Glass is transparent and thus reactions /interactions inside are clearly visible from outside



(ii) Glass is comparatively cheaper which reduces cost of equipping the school chemistry laboratory

(iii) glass is comparatively easy to clean/wash after use.

(iv) glass is comparatively unreactive to many chemicals.

Apparatus are designed for the purpose they are intended in a school chemistry laboratory:

(a) Apparatus for measuring volume

1. Measuring cylinder

Measuring cylinders are apparatus used to measure volume of liquid/ solutions. They are calibrated/ graduated to measure any volume required to the maximum. Measuring cylinders are named according to the maximum calibrated/graduated volume e.g.

“10ml” measuring cylinder is can hold maximum calibrated/graduated volume of “10mililitres” /“10 cubic centimetres”

“50ml” measuring cylinder is can hold maximum calibrated/graduated volume of “50mililitres” /“50 cubic centimetres”

“250ml” measuring cylinder is can hold maximum calibrated/graduated volume of “250mililitres” /“250 cubic centimetres”

“1000ml” measuring cylinder is can hold maximum calibrated/graduated volume of “1000mililitres” /“1000 cubic centimetres”

2. Burette

Burette is a long and narrow/thin apparatus used to measure small accurate and exact volumes of a liquid solution. It must be clamped first on a stand before being used. It has a tap to run out the required amount out. They are calibrated/ graduated to run out small volume required to the maximum 50ml/50cm³.



The maximum 50ml/50cm³ calibration/ graduation reading is at the **bottom**. This ensure the amount run **out** from a tap **below** can be determined directly from **burette reading** before and after during volumetric analysis.

Burettes are expensive and care should be taken when using them.

3. (i) Pipette

Pipette is a long and narrow/thin apparatus that widens at the middle used to measure and transfer small very accurate/exact volumes of a liquid solution.

It is open on either ends.

The maximum 25ml/25cm³ calibration/ graduation mark is a visible **ring** on one thin end.

To fill a pipette to this mark, the user must suck up a liquid solution upto a level above the mark then adjust to the mark using a finger.

This require practice.

(ii) Pipette filler

Pipette filler is used to suck in a liquid solution into a pipette instead of using the mouth. It has a suck, adjust and eject button for ensuring the exact volume is attained.

This requires practice.

4. Volumetric flask

A volumetric flask is thin /narrow but widens at the base/bottom. It is used to measure very accurate/exact volumes of a liquid solution.

The maximum calibration / graduation mark is a visible **ring**.

Volumetric flasks are named according to the maximum calibrated/graduated volume e.g.

“250ml” volumetric flask has a calibrated/graduated mark at exact volume of “250mililitres” /“250centimetres”

“1l” volumetric flask has a calibrated/graduated mark at exact volume of “one litre” /“1000 cubic centimetres”

“2l” volumetric flask has a calibrated/graduated mark at exact volume of “two litres” /“2000 cubic centimetres”



5. Dropper/teat pipette

A dropper/teat pipette is a long thin/narrow glass/rubber apparatus that has a flexible rubber head.

A dropper/teat pipette is used to measure very small amount/ drops of liquid solution by pressing the flexible rubber head. The number of drops needed are counted by pressing the rubber gently at a time

(b)Apparatus for measuring mass

1. Beam balance

A beam balance has a pan where a substance of unknown mass is placed. The scales on the opposite end are adjusted to “balance” with the mass of the unknown substance. The mass from a beam balance is in **grams**.

2. Electronic/electric balance.

An electronic/electric balance has a pan where a substance of unknown mass is placed. The mass of the unknown substance in **grams** is available immediately on the screen.

(c)Apparatus for measuring temperature

A thermometer has alcohol or mercury trapped in a bulb with a thin enclosed outlet for the alcohol/mercury in the bulb.

If temperature rises in the bulb, the alcohol /mercury expand along the thin narrow enclosed outlet.

The higher the temperature, the more the expansion.

Outside, a calibration /graduation correspond to this expansion and thus changes in temperature.

A thermometer therefore determines the temperature when the bulb is fully dipped in to the substance being tested. To determine the temperature of solid is thus very difficult.

(d)Apparatus for measuring time



The stop watch/clock is the standard apparatus for measuring time. Time is measured using hours, minutes and second.

Common school stop watch/clock has start, stop and reset button for determining time for a chemical reaction. This require practice.

(e) Apparatus for scooping

1. Spatula

A spatula is used to **scoop** solids which do not require accurate measurement. Both ends of the spatula can be used at a time.

A solid scooped to the **brim** is “one spatula end full” A solid scooped to **half brim** is “half spatula end full”.

2. Deflagrating spoon

A deflagrating spoon is used to **scoop** solids which do not require accurate measurement mainly for heating. Unlike a spatula, a deflagrating spoon is longer.

(f) Apparatus for putting liquids/solid for heating.

1. Test tube.

A test tube is a narrow/thin glass apparatus open on one side. The end of the opening is commonly called the “the mouth of the test tube”.

2. Boiling/ignition tube.

A boiling/ignition tube is a wide glass apparatus than a test tube open on one side. The end of the opening is commonly called the “the mouth of the boiling/ignition tube”.

3. Beaker.



Beaker is a wide calibrated/graduated lipped glass/plastic apparatus used for transferring liquid solution which do not normally require very accurate measurements

Beakers are named according to the maximum calibrated/graduated volume they can hold e.g.

“250ml” beaker has a maximum calibrated/graduated volume of “250mililitres” /“250 cubic centimetres”

“1l” beaker has a maximum calibrated/graduated volume of “one litre” /“1000 cubic centimetres”

“5 l” beaker has a maximum calibrated/graduated volume of “two litres” /“2000 cubic centimetres”

4. Conical flask.

A conical flask is a moderately narrow glass apparatus with a wide base and no calibration/graduation. Conical flasks thus carry/hold exact volumes of liquids that have been measured using other apparatus. It can also be put some solids. The narrow mouth ensures no spirage.

Conical flasks are named according to the maximum volume they can hold e.g.

“250ml” Conical flasks hold a maximum volume of “250mililitres” /“250 cubic centimetres”

“500ml” Conical flasks hold a maximum volume of “500ml” /“1000 cubic centimetres”

5. Round bottomed flask

A round bottomed flask is a moderately narrow glass apparatus with a wide round base and no calibration/graduation. Round bottomed flask thus carry/hold exact volumes of liquids that have been measured using other apparatus. The narrow/thin mouth prevents spirage. The flask can also hold (weighed) solids. A round bottomed flask must be held/ clamped when in use because of its wide narrow base.

6. Flat bottomed flask



A flat bottomed flask is a moderately narrow glass apparatus with a wide round base with a small flat bottom. It has no calibration/graduation.

Flat bottomed flask thus carry/hold exact volumes of liquids that have been measured using other apparatus. The narrow/thin mouth prevents spilage. They can also hold (weighed) solids. A flat bottomed flask must be held/ clamped when in use because it's flat narrow base is not stable.

(g) Apparatus for holding unstable apparatus(during heating).

1. Tripod stand

A tripod stand is a three legged metallic apparatus which unstable apparatus are placed on (during heating). Beakers, conical flasks, round bottomed flask and flat bottomed flasks are placed on top of tripod stand (during heating).

2. Wire gauze/mesh

Wire gauze/mesh is a metallic/iron plate of wires crossings. It is placed on top of a tripod stand:

- (i) ensure even distribution of heat to prevent cracking glass apparatus
- (ii) hold smaller apparatus that cannot reach the edges of tripod stand

3 Clamp stand

A clamp stand is a metallic apparatus which tightly hold apparatus at their “neck” firmly.

A clamp stand has a wide metallic base that ensures maximum stability. The height and position of clamping is variable. This require practice

4. Test tube holder

A test tube holder is a hand held metallic apparatus which tightly hold test/boiling/ignition tube at their “neck” firmly on the other end.



Some test tube holders have wooden handle that prevent heat conduction to the hand during heating.

5. Pair of tong.

A pair of tong is a scissor-like hand held metallic apparatus which tightly hold firmly a small solid sample on the other end.

6. Gas jar

A gas jar is a long wide glass apparatus with a wide base.

It is open on one end. It is used to collect/put gases.

This requires practice.

(h) Apparatus for holding/directing liquid solutions/funnels (to avoid spirage).

1. Filter funnel

A filter funnel is a wide mouthed (mainly plastic) apparatus that narrow drastically at the bottom to a long extension.

When the long extension is placed on top of another apparatus, a liquid solution can safely be directed through the wide mouth of the filter funnel into the apparatus without spirage.

Filter funnel is also used to place a filter paper during filtration.

2. Thistle funnel

A thistle funnel is a wide mouthed glass apparatus that narrow drastically at the bottom to a very long extension.

The long extension is usually drilled through a stopper/cork.

A liquid solution can thus be directed into a stoppered container without spirage

3. Dropping funnel

A dropping funnel is a wide mouthed glass apparatus with a tap that narrow drastically at the bottom to a very long extension.

The long extension is usually drilled through a stopper/cork.

A liquid solution can thus be directed into a stoppered container without spirage at the rate determined by adjusting the tap.

4. Separating funnel



A separating funnel is a wide mouthed glass apparatus with a tap at the bottom narrow extension.

A liquid solution can thus be directed into a separating funnel without spirage. It can also safely be removed from the funnel by opening the tap.

It is used to separate two or more liquid solution mixtures that form layers/immiscibles. This requires practice.

(h) Apparatus for heating/Burners

1. Candle, spirit burner, kerosene stove, charcoal burner/jiko are some apparatus that can be used for heating.

Any flammable fuel when put in a container and ignited can produce some heat.

2. Bunsen burner

The Bunsen burner is the **standard** apparatus for heating in a Chemistry school laboratory.

It was discovered by the German Scientist Robert Wilhelm Bunsen in 1854.

(a) Diagram of a Bunsen burner



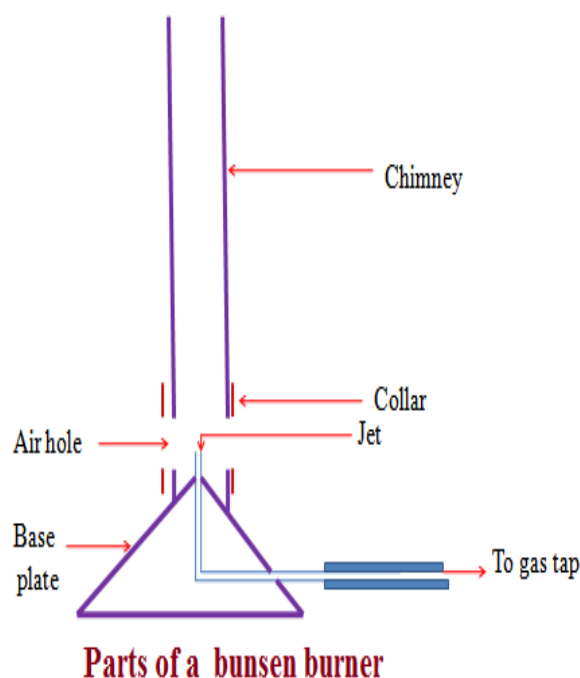

A Bunsen burner uses butane/laboratory gas as the fuel. The butane/laboratory gas is highly flammable and thus usually stored safely in a secure chamber outside Chemistry school laboratory. It is tapped and distributed into the laboratory through gas pipes.

The gas pipes end at the gas tap on a chemistry laboratory bench. If opened the gas tap releases butane/laboratory gas. Butane/laboratory gas has a characteristic odour/smell that alerts leakages/open gas tap.

The Bunsen burner is fixed to the gas tap using a strong rubber tube.

The Bunsen burner is made up of the following parts:

(i) **base plate** –to ensure the burner can stand on its own

(ii) **Jet**-a hole through which laboratory gas enters the burner

(iii) **Collar/sleeve**-adjustable circular metal attached to the main chimney/burell with a side hole/entry. It controls the amount of air entering used during burning.

(iv) **Air hole**- a hole/entry formed when the collar side hole is in line with chimney side hole. If the collar side hole is **not** in line with chimney side hole, the air hole is said to be “closed” If the collar side hole is **in line** with chimney side hole, the air hole is said to be “open”

(v) **Chimney**- tall round metallic rod attached to the base plate.

(b) Procedure for lighting/igniting a Bunsen burner

1. Adjust the collar to ensure the air holes are closed.
2. Connect the burner to the gas tap using a rubber tubing. Ensure the rubber tubing has no side leaks.
3. Turn on the gas tap.
4. Ignite the top of the chimney using a lighted match stick/gas lighter/wooden splint.
5. Do not delay excessively procedure (iv) from (iii) to prevent highly flammable laboratory gas from escaping/leaking.

(c) Bunsen burner flames

A Bunsen burner produces two types of flames depending on the amount of air entering through the air holes.

If the air holes are **fully open**, a **non luminous** flame is produced. If the air holes are **fully closed**, a **luminous flame** is produced. If the air air holes are **partially open/closed**, a **hybrid** of non luminous and luminous flames is produced.



Characteristic differences between luminous and non-luminous flame

Luminous flame	Non-luminous flame
1. Produced when the air holes are fully/completely closed .	1. Produced when the air holes are fully/completely open .
2. when the air holes are fully/completely closed there is incomplete burning/ combustion of the laboratory gas	2. when the air holes are fully/ completely open there is complete burning/ combustion of the laboratory gas
3. Incomplete burning/ combustion of the laboratory gas produces fine unburnt carbon particles which make the flame sooty/smoky	3. complete burning/ combustion of the laboratory gas does not produce carbon particles. This make the flame non- sooty /non- smoky .
4. Some carbon particles become white hot and emit light. This flame is thus bright yellow in colour producing light . This makes luminous flame useful for lighting	4. Is mainly blue in colour and is hotter than luminous flame. This makes non-luminous flame useful for heating
5. Is larger, quiet and wavy /easily swayed by wind	5. Is smaller, noisy and steady
Luminous flame has three main regions: (i) the top yellow region where there is incomplete combustion/burning (ii) the region of unburnt gas below the yellow region where the gas does not burn (iii) blue region on the sides of region of unburnt gas where there	Non-luminous flame has four main regions: (i) the top colourless region (ii) blue region just below where there is complete burning. It is the hottest region (iii) green region surrounded by the blue region where there is complete burning (ii) the region of unburnt gas at the innermost surrounded by green and blue regions. No burning takes place here



is complete burning	
---------------------	--

Scientific apparatus are drawn:

- (i) using a proportional **two** dimension(**2D**) cross-sections. Three dimensions (3D) are not recommended.
- (ii) straight edges of the apparatus on a scientific diagram should be drawn using ruler.
- (iii) curved edges of the apparatus on a scientific diagram should be drawn using free hand.
- (iv) The bench, tripod or clamp to support apparatus which cannot stand on their own should be shown.



FOR: Form 2, 3 & 4 NOTES, latest & Updated Schemes of Work, Quality Revision Booklets, Entry, Mid-Term & End-Term Exams, All KASNEB notes, Set-Books Acted Videos.....

WhatsApp Sir Obiero Amos @ 0706 851 439



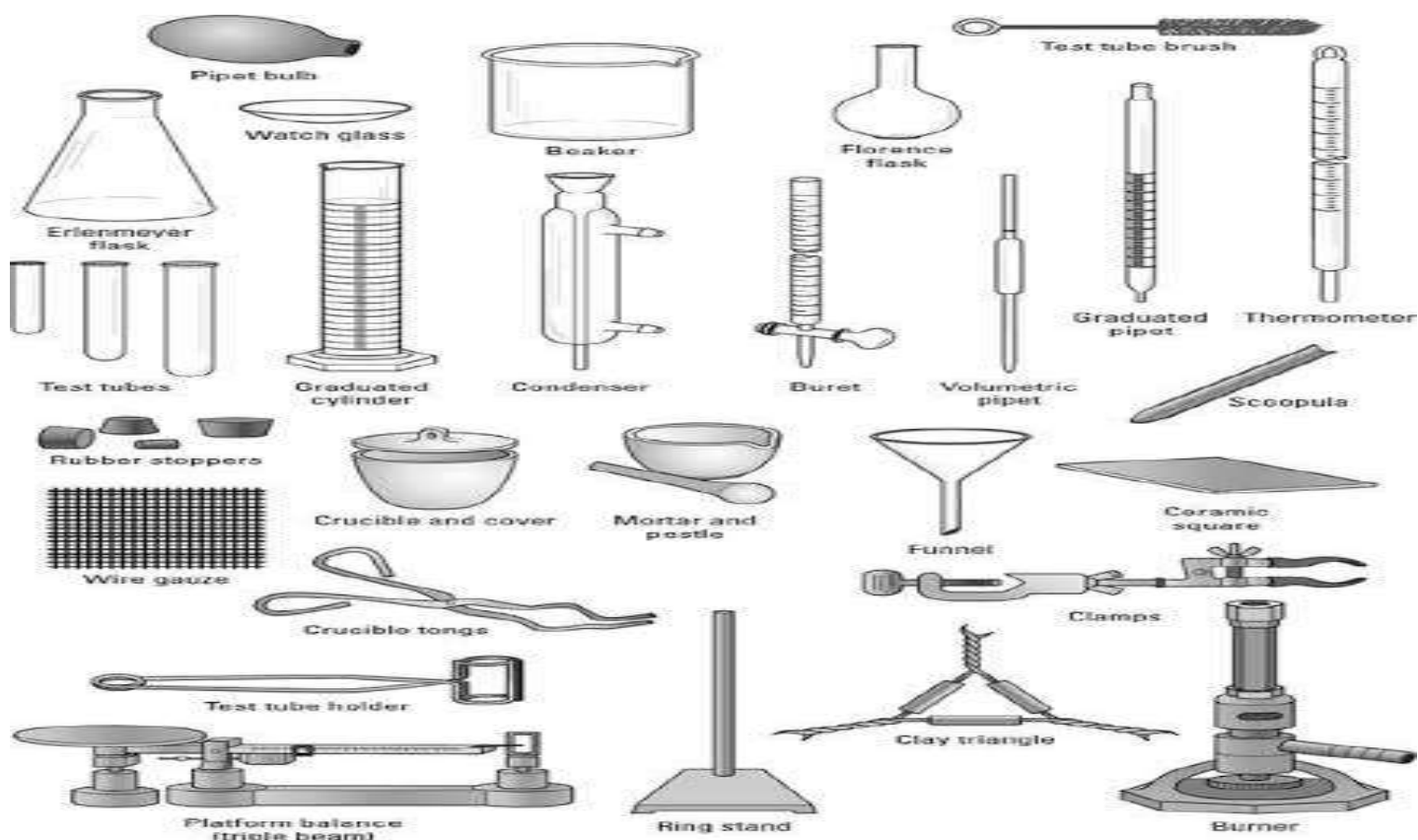

laboratory equipment

glass rod
beaker
spatula
dropper
syringe
plunger
pipette
retort
flask
gauze mat
tripod
rubber tubing
Bunsen burner
burette (also buret)
stand
graduated cylinder
evaporating dish
crucible
mortar
pestle
Petri dish
tongs
filter paper
funnel
test tube rack
magnet
microscope
eyepiece
objective lens
slide

Call us on for science projects: (+91)-8989568778

CLASSIFICATION OF SUBSTANCES

Substances are either pure or impure. A pure substance is one which contains only one substance.

An impure substance is one which contains two or more substances. A pure substance is made up of a pure solid, pure liquid or pure gas.

A mixture is a combination of two or more pure substances which can be separated by physical means. The three states of matter in nature appear mainly as mixtures of one with the other.

Common mixtures include:

(a) Solutions/solid-liquid dissolved mixture

Experiment:

To make a solution of copper(II)sulphate(VI)/Potassium manganate(VII) /sodium chloride

Procedure

Put about 100 cm³ of water in three separate beakers. Separately place a half spatula end full of copper(II)sulphate(VI) ,Potassium manganate(VII) and sodium chloride crystals to each beaker. Stir for about two minutes.

Observation

Copper(II)sulphate(VI) crystals dissolve to form a blue solution

Potassium manganate(VII) crystals dissolve to form a purple solution

Sodium chloride crystals dissolve to form a colourless solution

Explanation

Some solids, liquids and gases dissolve in some other liquids.

A substance/liquid in which another substance dissolves is called solvent.

A substance /solid /gas which dissolves in a solvent is called solute.

When a solute dissolves in a solvent it forms a uniform mixture called **solution**.

A solute dissolved in water as the solvent exists in another state of matter called **aqueous state**. Water is referred as the **universal solvent** because it dissolves many solutes. A solute that dissolves in a solvent is said to be **soluble**. Soluble particles uniformly spread between the particles of water/solvent and cannot be seen.

FOR: Form 2, 3 & 4 NOTES, latest & Updated Schemes of Work, Quality Revision Booklets, Entry, Mid-Term & End-Term Exams, All KASNEB notes, Set-Books Acted Videos.....

WhatsApp Sir Obiero Amos @ 0706 851 439



Solute + Solvent -> solution
Solute + Water -> Aqueous solution of solute

The solute dissolved in water gives the **name** of the solution

e. g.

1. Sodium chloride solution is a solution formed after dissolving sodium chloride crystals/solid in water. Sodium chloride exists in aqueous state after dissolving.

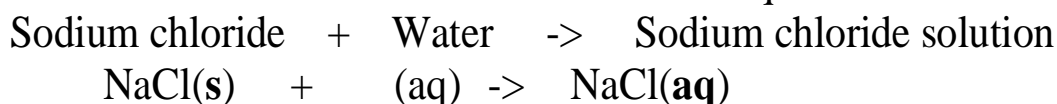

2. Ammonia solution is a solution formed after dissolving ammonia gas in water. Ammonia exists in aqueous state after dissolving.

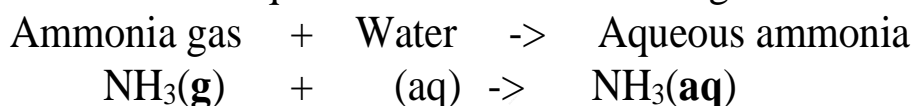

3. Copper (II)sulphate(VI) solution is a solution formed after dissolving Copper(II) sulphate (VI) crystals/solid in water. Copper (II)sulphate(VI) exist in aqueous state after dissolving.

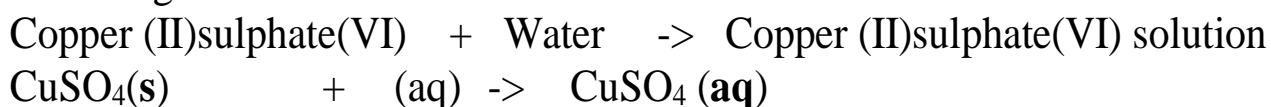

4. Potassium manganate(VII) solution is a solution formed after dissolving Potassium manganate(VII) crystals/solid in water.

Potassium manganate(VII) exist in aqueous state after dissolving.

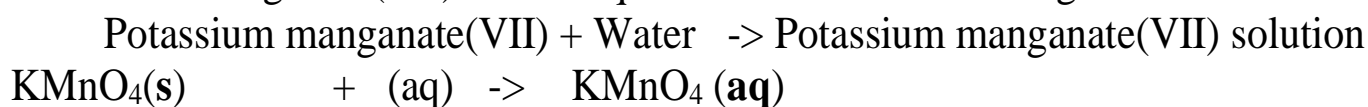

(b) Suspension/ precipitates/solid-liquid mixture which do not dissolve

Experiment: To make soil, flour and Lead(II)Iodide suspension/precipitate

Procedure

Put about 100 cm³ of water in three separate beakers. Separately place a half spatula end full of soil, maize and lead(II)Iodide to each beaker. Stir for about two minutes.

Observation

Some soil, maize and lead(II)Iodide float in the water

A brown suspension/precipitate/particles suspended in water containing soil

A white suspension/precipitate/particles suspended in water containing flour

A yellow suspension/precipitate/particles suspended in water containing Lead(II)iodide.

Some soil, maize and lead(II)Iodide settle at the bottom after some time.

Explanation

Some solid substances do not dissolve in a liquid. They are said to be **insoluble** in the solvent. When an insoluble solid is put in liquid:

(i) some particles remain **suspended/floating** in the liquid to form a **suspension** /**precipitate**.

(ii) some particles **sink/settle** to the bottom to form **sediments** after being allowed to stand.

An **insoluble** solid acquire the colour of the suspension/precipitate .e.g .

1. A **white** suspension /precipitate has some fine **white** particles suspended /floating in the liquid. **Not** “white solution”

2. A **blue** suspension /precipitate has some fine **blue** particles suspended /floating in the liquid.

3. A **green** suspension /precipitate has some fine **green** particles suspended /floating in the liquid.



4.A **brown** suspension /precipitate has some fine **brown** particles suspended /floating in the liquid.

4.A **yellow** suspension /precipitate has some fine **yellow** particles suspended /floating in the liquid.

(c) (i) Miscibles /Liquid-liquid mixtures

To form water-ethanol and Kerosene-turpentine miscibles

Procedure

(i) Measure 50cm³ of ethanol into 100cm³ beaker. Measure 50cm³ of water. Place the water into the beaker containing ethanol. Swirl for about one minute.

(ii) Measure 50cm³ of kerosene into 100cm³ beaker. Measure 50cm³ of turpentine oil. Place the turpentine oil into the beaker containing kerosene. Swirl for about one minute.

Observation

Two liquids do not form layers.

Ethanol and water form a uniform mixture.

Kerosene and turpentine oil form uniform mixture

Explanation

Ethanol is miscible in Water. Kerosene is miscible in turpentine oil. Miscible mixture form uniform mixture. They do not form layers. The particles of one liquid are smaller than the particles of the other. The smaller particles occupy the spaces between the bigger particles.

(ii) Immiscibles /Liquid-liquid mixtures

To form water-turpentine oil and Kerosene-water miscibles

Procedure

(i) Measure 50cm³ of water into 100cm³ beaker. Measure 50cm³ of turpentine oil. Place the oil into the beaker containing water. Swirl for about one minute.

(ii) Measure 50cm³ of water into 100cm³ beaker. Measure 50cm³ of kerosene. Place the kerosene into the beaker containing water. Swirl for about one minute.

Observation

Two liquids form layers.



Turpentine and water do not form a uniform mixture.

Water and kerosene do not form uniform mixture

Explanation

Kerosene is immiscible in Water. Water is immiscible in turpentine oil. Immiscible mixtures do not form uniform mixtures. They form layers. The size of the particles of one liquid is almost equal to the particles of the other. The particles of one liquid cannot occupy the spaces between the particles of the other. The heavier particles settle at the bottom. The less dense particles settle on top.

(d)Solid-solid mixtures/Alloys

Before solidifying, some heated molten/liquid metals dissolve in another metal to form a uniform mixture of the two. On solidifying, a uniform mixture of the metals is formed. A uniform mixture of two metals on solidifying is called **alloy**. In the alloy, one metallic particle occupies the spaces between the metallic particles of the other.

c) Common alloys of metal.

Alloy name	Constituents of the alloy	Uses of the alloy
Brass	Copper and Zinc	Making screws and bulb caps
Bronze	Copper and Tin	Making clock springs,electrical contacts and copper coins
Soldier	Lead and Tin	Soldering, joining electrical contacts because of its low melting points and high thermal conductivity
Duralumin	Aluminium, Copper and Magnesium	Making aircraft, utensils, windows frames because of its light weight and corrosion resistant.



Steel	Iron, Carbon, Manganese and other metals	Railway lines, car bodies girders and utensils.
Nichrome	Nichrome and Chromium	Provide resistance in electric heaters and ovens
German silver	Copper, Zinc and Nickel	Making coins

METHODS OF SEPARATING MIXTURES

Mixtures can be separated from applying the following methods:

(a) Decantation

Sediments can be separated from a liquid by pouring out the liquid. This process is called **decantation**.

Experiment

Put some sand in a beaker. Add about 200cm³ of water. Allow sand to settle. Pour off water carefully into another beaker.

Observation

Sand settles at the bottom as sediments.

Less clean water is poured out.

Explanation

Sand does not dissolve in water. Sand is denser than water and thus settles at the bottom as **sediment**. When poured out, the less dense water flows out.

(b) Filtration



Decantation leaves suspended particles in the liquid after separation. Filtration is thus improved decantation.

Filtration is the method of separating insoluble mixtures/particles/solids from a liquid.

Experiment : To separate soil and water using filtration

Fold a filter paper to fit well into a filter funnel. Place the funnel in an empty 250 cm³ beaker.

Put one spatula end full of soil into 50cm³ of water. Stir. Put the soil/water mixture into the filter funnel.

Observations

Clean water is collected **below** the filter funnel.

Soil remains **above** the filter paper.

Explanation

A filter paper is **porous** which act like a fine sieve with very small **holes**. The holes allow smaller water particles to pass through but do not allow bigger soil particles. The liquid which passes through is called **filtrate**. The solid which do not pass through is called **residue**.

Set up of apparatus

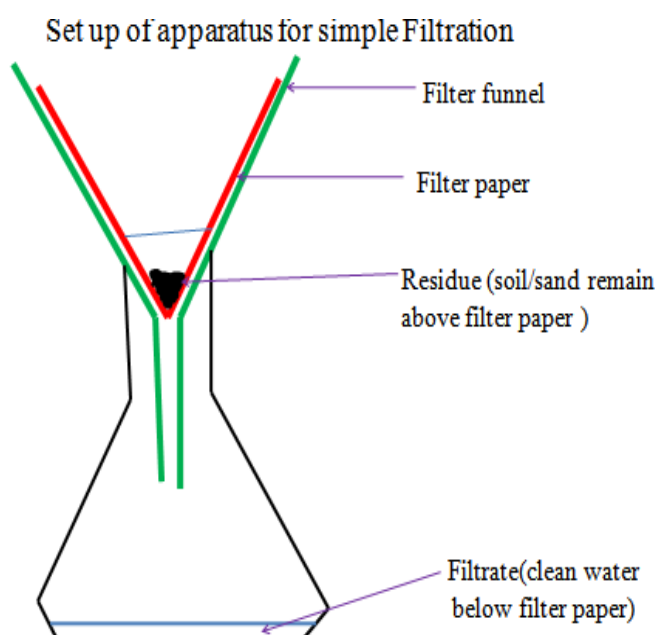

In industries, filtration is used in engine filters to clean up air.

Processes in purification/treatment of water

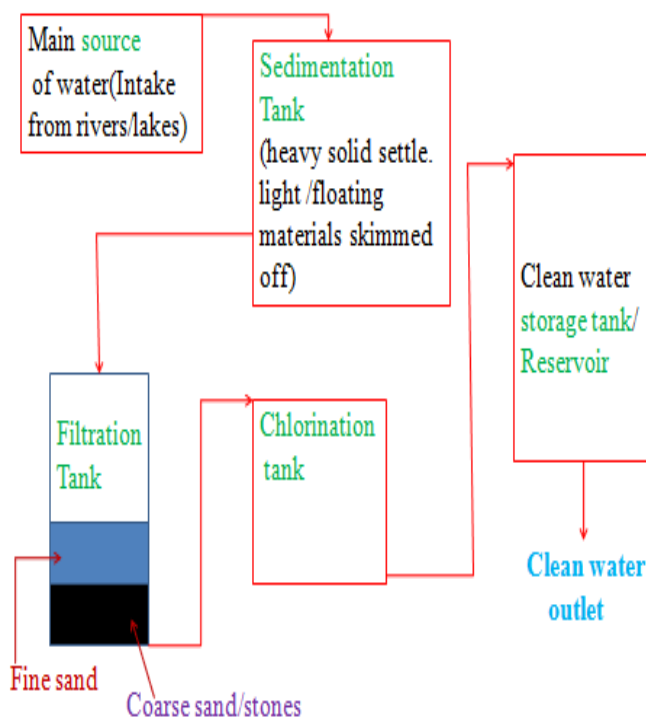

(c)Evaporation

Evaporation is a method of separating a solute/solid from its solution. This involves heating a solution (solvent and solute) to vapourize the solvent out of the solution mixture leaving pure solute/solid. If a mixture contain insoluble solid, they are filtered out.

Experiment : **To separate a mixture of soil and salt(sodium chloride) .**

Procedure:

Put one spatula end full of soil on a filter paper.

Put one spatula full of common salt/sodium chloride into the same filter paper. Mix well using the spatula,.

Place about 200cm³ of water into a beaker.

Put the contents of the filter paper into the water. Stir thoroughly using a glass/stirring rod for about one minute.

Fold a filter paper into a filter funnel.

Pour half portion of the contents in the beaker into the filter funnel.

Put the filtrate into an evaporating dish. Heat on a water bath.

Observation

(i) On mixing

Colourless crystals and brown soil particles appear on the filter paper.

(ii) On adding water

Common soil dissolves in water. Soil particles do not dissolve in water.

(iii) On filtration

Colourless liquid collected as filtrate below the filter funnel/paper.

Brown residue collected above the filter funnel/paper.

(iv) On evaporation

Colourless crystals collected after evaporation

Explanation

Solid mixture of sand and common salt take the colours of the two.

On adding water, common salt dissolve to form a solution .

Soil does not because it is insoluble in water and thus forms a suspension.

On filtration, a residue of insoluble soil does not pass through the filter paper.

It is collected as residue.

Common salt solution is collected as filtrate.

On heating the filtrate, the solvent/water evaporate/vapourize out of the evaporating dish leaving common salt crystals.

Vapourization/evaporation can take place even without heating.

This is the principle/process of drying wet clothes on the hanging line.

Set up of apparatus



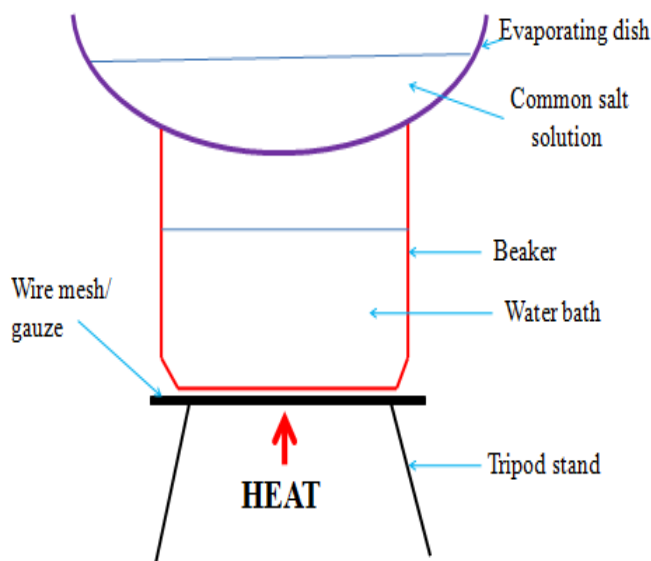

(d) Distillation

Distillation is an improved evaporation where both the solute and the solvent in the solution are separated /collected. Distillation therefore is the process of separating a solution into constituent solid solute and the solvent. It involves heating the solution to evaporate/vapourize the solvent out. The solvent vapour is then condensed back to a liquid.

Experiment: To obtain copper(II)sulphate (VI) crystals and water from copper (II) sulphate(VI) solution.

Procedure:

Put one spatula end full of copper(II)sulphate (VI) crystals into a 250cm³ beaker.

Place about 200cm³ of water into the beaker.

Stir thoroughly using a glass/stirring rod for about one minute.

Pour half portion of the contents in the beaker into a round bottomed/flat/conical flask broken porcelain/sand/glass into the flask.

Put a few pieces of b Stopper the flask.

Connect the flask to a liebig condenser using delivery tube.

Place a 200cm³ clean empty beaker/conical flask as a receiver at the end of the liebig condenser.

Circulate water in the liebig condenser.

Heat the flask strongly on a tripod stand with wire mesh/gauze until there is no more visible **boiling bubbles** in the flask.

Observation

Copper (II)sulphate (VI) crystals dissolve in water to form a blue solution.

On heating, colourless liquid is collected in the receiver.

Blue crystals are left in the flask.

(if gently heated further, the blue crystals turn to white powder)

Explanation

On heating blue Copper (II)sulphate (VI) solution, the colourless liquid solvent evaporate/vapourize .

The liquid vapour/gas passes through the delivery tube to the liebig condenser.

The liebig condenser has a cold water **inlet** near the receiver and cold water **out** let.

This ensures efficient cooling. If the cold water **outlet/inlet** is reversed, the water circulation would be less efficient.

The water in the receiver would be warm. In the liebig condenser, the cold water, condenses the liquid vapour into liquid.

The condensed liquid collects in the receiver as **distillate**.

The solute of blue Copper (II)sulphate (VI) crystals is left in the flask as **residue**.

During simple distillation, therefore, the solution is heated to vapourize /evaporate the solvent/one component which is condensed at a different part of the apparatus.

The purpose of pieces of broken porcelain/porous pot/glass/sand/ is to:

(i) prevent bumping of the solution during boiling.

(ii) ensure smooth and even boiling.

Salty sea water can be made pure through simple distillation.



Any mixture with a large difference /40°C in boiling point can be separated using simple distillation.

Set up of apparatus

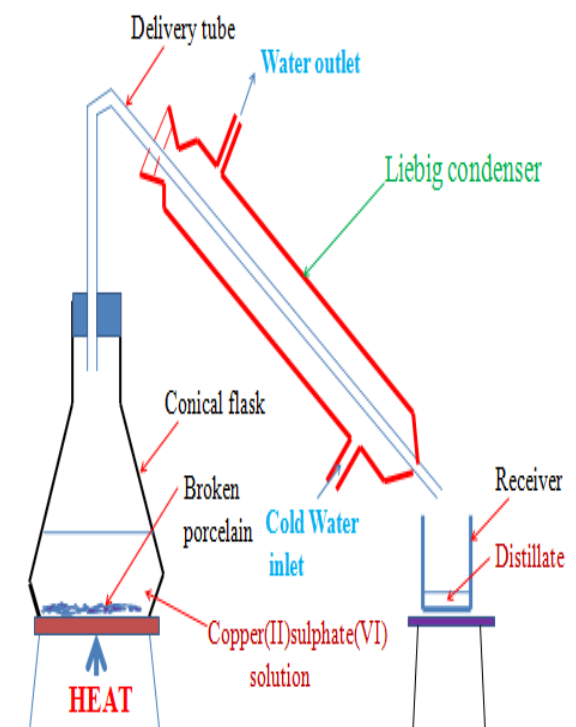

(e) Fractional distillation

Fractional distillation is an improved simple distillation used specifically to separate miscible mixtures with very **close /near** boiling points.

Fractional distillation involves:

(i) Heating the mixture in a conical/round bottomed /flat bottomed flask.

The pure substance with a lower boiling point and thus more volatile evaporates/boils/vapourizes first.

e.g.

Pure ethanol has a boiling point of 78°C. Pure water has a boiling point of 100 °C at sea level/one atmosphere pressure.

When a miscible mixture of ethanol and water is heated, ethanol vapourizes /boils/ evaporates first because it is more volatile.

(ii)The conical/round bottomed /flat bottomed flask is connected to a long glass tube called **fractionating column**.

The purpose of the fractionating column is to offer areas of condensation for the less volatile pure mixture.

The fractionating column is packed with glass beads/broken glass/ porcelain/ shelves to increase the surface area of condensation of the less volatile pure mixture.

(iii)When the vapours rise they condense on the glass beads/broken glass /porcelain / shelves which become hot.

When the temperature of the glass beads/broken glass/porcelain/shelves is beyond the boiling point of the less volatile pure substance, the pure substance rise and condensation take place on the glass beads/broken glass/porcelain/shelves at a higher level on the fractionating column.

The less volatile pure substance trickles/drips back down the fractionating column or back into the conical/round bottomed /flat bottomed flask to be heated again. e.g.

If the temperature on glass beads/broken glass/porcelain/shelves is beyond 78°C, the **more volatile** pure ethanol rise to condense on the glass beads/broken glass /porcelain/shelves **higher** in the fractionating column.

Water condenses and then drip/trickle to the glass beads/broken glass /porcelain /shelves **lower** in the fractionating column because it is **less volatile**.

(iv)The fractionating column is connected to a liebig condenser. The liebig condenser has a cold water inlet and outlet circulation.

The more volatile mixture that reach the top of the fractionating column is condenses by the liebig condenser into a receiver. It is collected as the first fraction.

(v)At the top of the fractionating column, a thermometer is placed to note/monitor the temperature of the boiling mixtures .

Pure substances have constant/fixed boiling point. When one mixture is completely separated, the thermometer reading rises.



e.g. The thermometer reading remains at 78°C when ethanol is being separated. When no more ethanol is being separated, the mercury/alcohol level in the thermometer rises.

(vi) The second /subsequent fractions are collected in the receiver after noting a rise the mercury/alcohol level in the thermometer.

e.g.
The thermometer reading rises to 100°C when water is being separated. It is passed through the liebig condenser with the cold water inlet and outlet circulation. It is collected different receiver as the second/subsequent fraction.

(vii) Each fraction collected should be confirmed from known physical/chemical properties/characteristic.

e.g.
Ethanol
Ethanol is a colourless liquid that has a characteristic smell .When it is put in a watch glass then ignited, it catches fire and burn with a blue flame.

Water
Water is a colourless liquid that has no smell/odour .When it is put in a watch glass then ignited, it does not catch fire.

Set up of apparatus



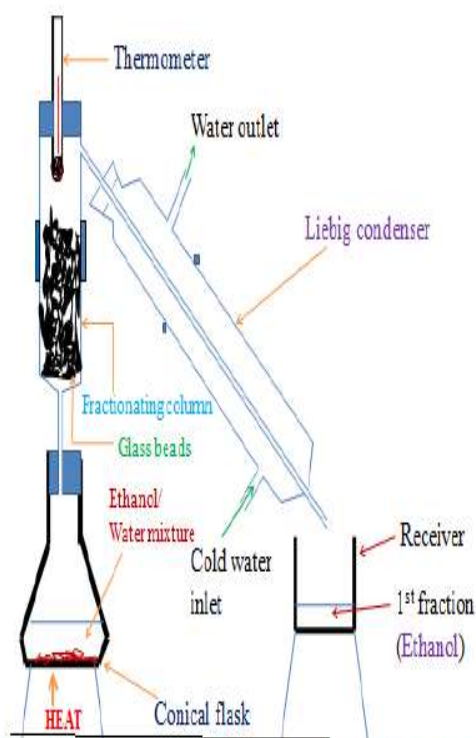

Fractional Distillation of miscible ethanol/water mixture

Industrial application of Fractional distillation

On a large scale, fractional distillation is used:

(i) In fractional distillation of crude oil in an oil refinery.

Crude oil is a mixture of many fractions. When heated in a furnace, the different fractions separate out according to their boiling point. In Kenya, fractional distillation takes place at Changamwe in Mombasa.

(ii) In fractional distillation of air.

Air contains a mixture of three main useful gases which are condensed by cooling to very low temperature (-200°C) to form a liquid. The liquid is then heated. Nitrogen is the most volatile (-196°C) and thus comes out as the first fraction. Argon (at -186°C) is the second fraction. Oxygen (at -183°C) is the last fraction. The three gases are very useful industrial gases.

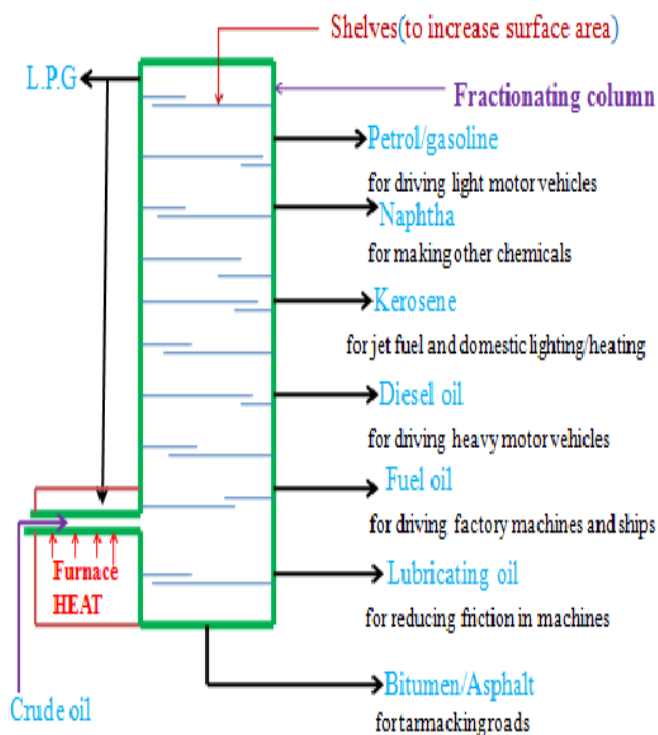

Industrial fractional distillation of crude oil in an oil refinery

(f) Separation of immiscibles (Using a separating funnel)

Two or more liquids that form layers on mixing are immiscible. Immiscible mixture arrange themselves according to their densities

i.e The denser liquid sink to the bottom. The less dense liquid floats on the denser one. Immiscible mixtures can be separated from each other by using a **separating funnel**.

Experiment: To separate an immiscible mixture of paraffin and water.

Procedure

Place about 100cm³ of water into a 250cm³ beaker. Add about 100cm³ of paraffin into the beaker. Stir.

Transfer the mixture into a separating funnel. Allow to settle for about one minute. Open the tap, run out the lower layer out slowly into a clean beaker. Close the tap when the upper layer is very close to the tap.

Run out the intermediate small amount of the mixture near the tap into a beaker. Discard it.

Run out the remaining upper layer into a fresh beaker.

Place a portion of upper and lower layer into a watch glass separately after separating each. Ignite.

Observation

Water and paraffin are both colourless liquids.

Two layers are formed on mixing.

Colourless odourless liquid collected first. It does not catch fire.

A colourless liquid with characteristic smell collected later/second. It catches fire and burn with a yellow smoky flame.

Explanation

Water and paraffin are immiscible. Water is denser than paraffin. When put in a separating funnel, paraffin float on water. On opening the tap, water runs out. A mixture of water and paraffin at the junction of the two is discarded. It is not pure.

Set up of apparatus

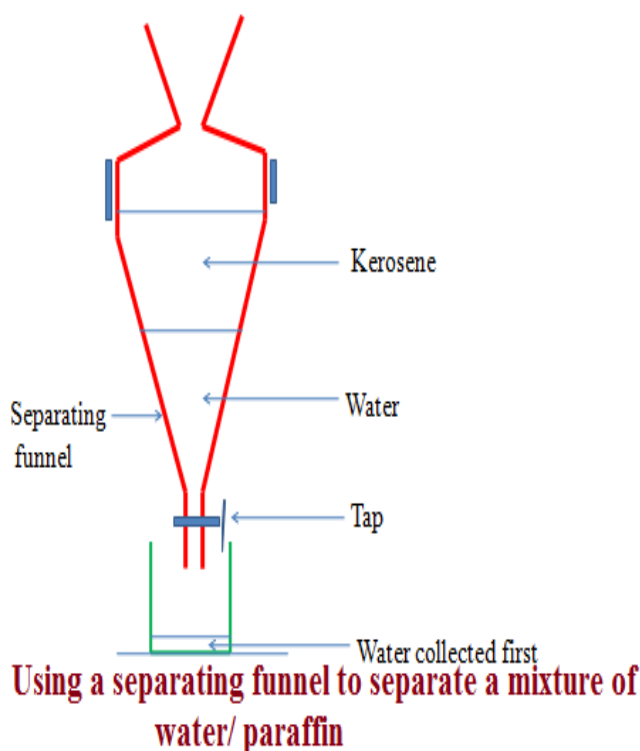

(g) Sublimation/deposition

Some solids on heating do not melt to a liquid but change directly to a gas. The process by which a solid changes to a gas is called **sublimation**. The gas cools back and changes directly to a solid. The process by which a gas changes to a solid is called **deposition**. Sublimation and deposition therefore are the same but opposite processes.

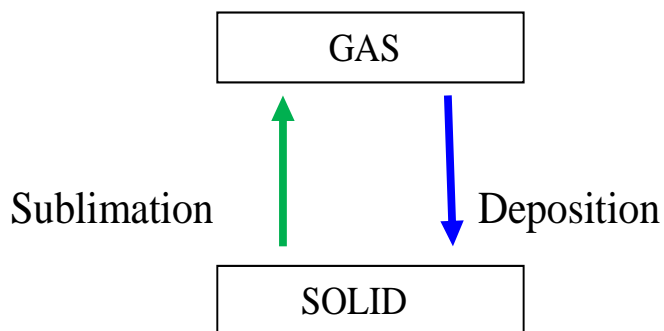

Some common substances that undergo sublimation/ deposition include:

- (i) Iodine
- (ii) Carbon(IV)oxide
- (iii) Camphor
- (iv) ammonium chloride
- (v) Iron(III)chloride
- (vi) Aluminium(III)chloride
- (vii) benzoic acid

If a mixture has any of the above as a component, then on heating it will change to a gas and be deposited away from the source of heating.

Procedure

Place about one spatula full of ammonium chloride crystals into a clean dry 100cm³ beaker. Add equal amount of sodium chloride crystals into the beaker. Swirl to mix. Place the beaker on a tripod stand.

Put about 100cm³ of water into another beaker. Place carefully the beaker containing water on top of the beaker containing the solid mixture. Light/ignite a burner and heat the solid.

Set up of apparatus:

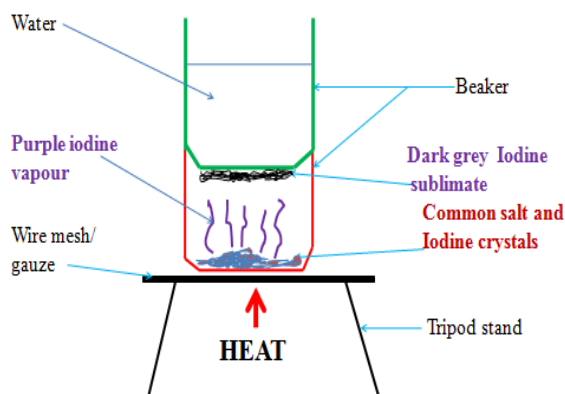

Method 2:

Using sublimation to separate common salt and Iodine crystals

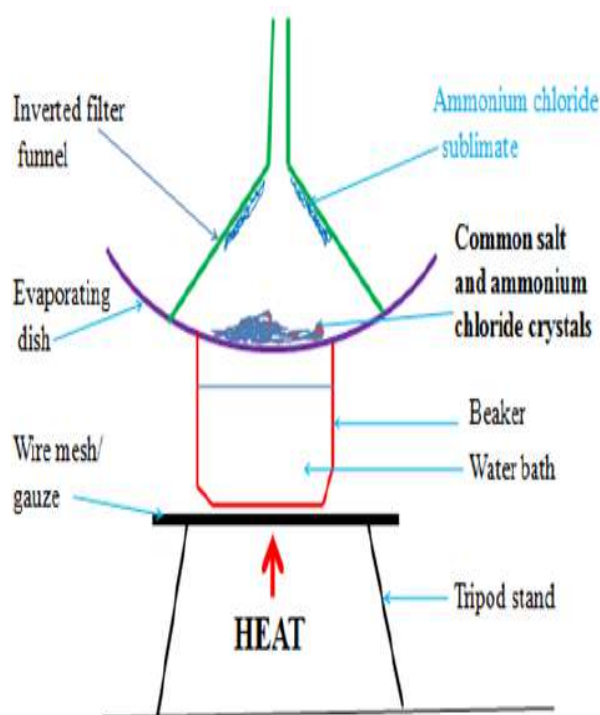

Method 1

Using sublimation to separate common salt and ammonium chloride

Observation

(i) With ammonium chloride/common salt mixture

White fumes produced .

White sublimate deposited

Colourless residue left

(ii) With Iodine/common salt mixture

Purple fumes produced .

Dark grey sublimate deposited

Colourless residue left

Explanation

(i) On heating a mixture of ammonium chloride and common salt, a white fumes of ammonium chloride is produced. The white fumes solidify as white sublimate on the cooler parts. Common salt remains as residue.

Chemical equation:

Ammonium chloride **solid** \rightleftharpoons Ammonium chloride **gas**

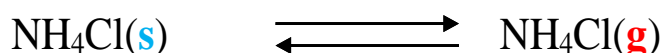

(ii) On heating a mixture of Iodine and common salt, a purple fumes of Iodine vapour is produced. The purple fumes solidify as dark grey sublimate on the cooler parts. Common salt remains as residue.

Chemical equation:

Iodine **solid** \rightleftharpoons Iodine **gas**

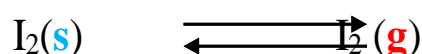

(h) Chromatography

Chromatography is a method of separating components of a solution mixture by passing it through a medium where the different components move at different rates. The medium through which the solution mixture is passed is called **absorbent material**.

Paper chromatography is a method of separating coloured dyes by using paper as the absorbent material.

Since dyes are insoluble/do not dissolve in water, ethanol and propanone are used as suitable solvents for dissolving the dye.

Practically, a simple paper chromatography involve placing a dye/material on the absorbent material, adding slowly a suitable soluble solvent on the dye/material using a dropper, the solvent spread out on the absorbent material carrying the soluble dye away from the origin.

The spot on which the dye is initially/originally placed is called **baseline**. The farthest point the solvent spread is called **solvent front**.

The farthest a dye can be spread by the solvent depend on:

(i) density of the dye-the denser the dye, the less it spread from the baseline by the solvent.



(ii) Stickiness of the dye-some dyes sticks on the absorbent material more than other thus do not spread far from baseline.

Experiment: To investigate the colours in ink

Procedure

Method 1

Place a filter paper on a an empty beaker. Put a drop of black/blue ink in the centre of the filter paper. Wait for about one minute for the ink drop to spread. Using a clean teat pipette/dropper add one drop of ethanol/propanone. Wait for about one minute for the ink drop to spread further. Add about twenty other drops of ethanol waiting for about one minute before each addition. Allow the filter paper to dry.

Experiment: To investigate the colours in ink

Procedure

Method 2

Cut an 8 centimeter thin strip of a filter paper. At about 3cm on the strip, place a drop of ink. Place the filter paper in a 10cm length boiling tube containing 5cm³ of ethanol. Ensure the cut strip of the filter paper just dips into the ethanol towards the ink mark. Cover the boiling tube. Wait for about twenty minutes. Remove the boiling tube and allow the filter paper to dry.

Set up of apparatus

Method 1



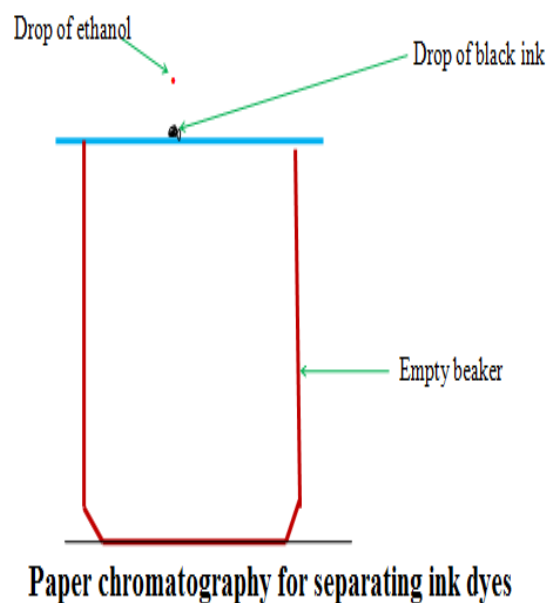

Set up of apparatus Method 2

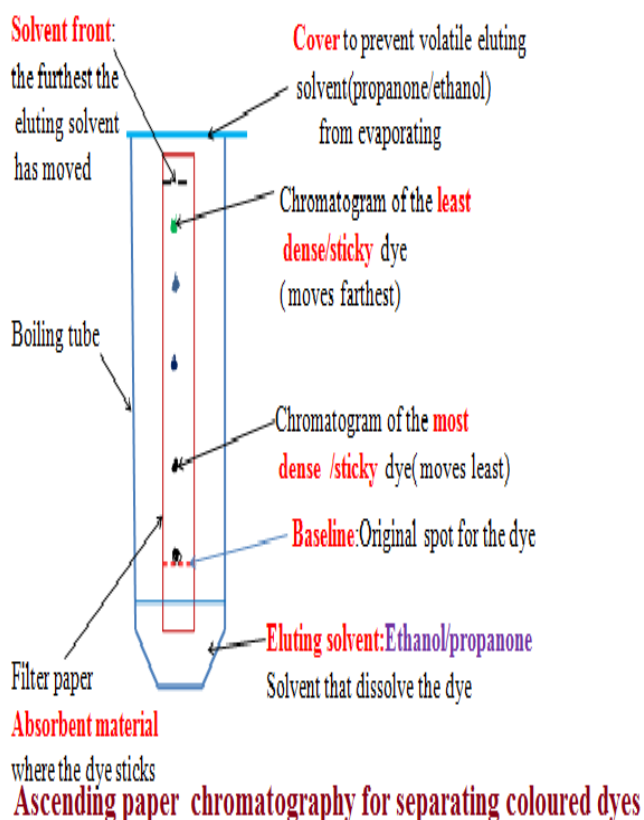

Explanation

When a drop of ink is placed on an absorbent material it sticks. On adding an eluting solvent, it dissolves the dye spread out with it. The denser and sticky pure dye move least. The least dense/sticky pure dye move farthest. A pure dye will produce the same chromatogram/spot if the same eluting solvent is used on the same absorbent material. Comparing the distance moved by a pure dye with a mixture, the coloured dyes in a mixture can be deduced as below:

Example 1

The chromatogram of pure dyes A, B, C and a dye mixture D is shown below. Determine the pure dyes present in D. On the diagram show:

- (i) the solvent front
- (ii) baseline
- (iii) the most soluble pure dye

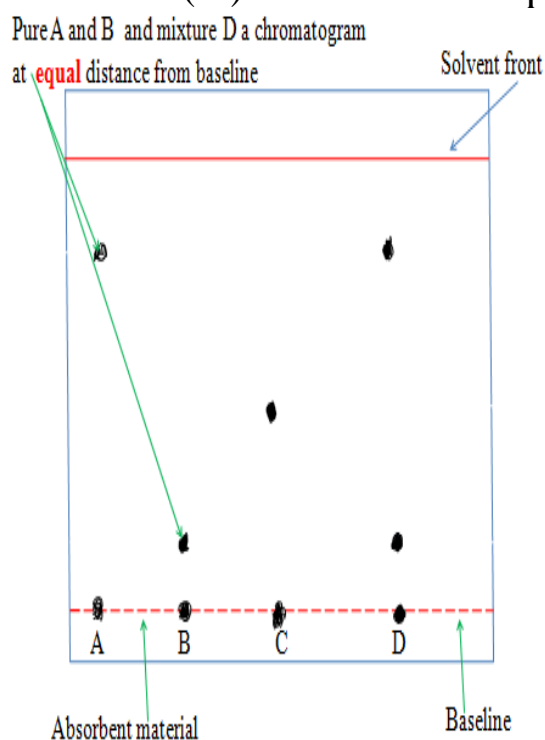

Chromatogram showing pure A,B,C and mixture D

(i) Solvent extraction

Solvent extraction is a method of separating oil from nuts/seeds. Most nuts contain oil. First the nuts are crushed to reduce their size and increase the surface area. A suitable volatile solvent is added. The mixture is filtered. The filtrate solvent is then allowed to crystallize leaving the oil/fat. If a filter paper is rubbed/smeared with the oil/fat, it becomes translucent. This is the test for the presence of oil/fat.

Experiment: To extract oil from Macadamia nut seeds

Procedure

Crush Macadamia nut seeds from the hard outer cover. Place the inner soft seed into a mortar. Crush (add a little sand to assist in crushing).

Add a little propanone and continue crushing. Continue crushing and adding a little propanone until there is more liquid mixture than the solid. Decant/filter. Put the filtrate into an evaporating dish. Vapourize the solvent using solar energy /sunlight. Smear/rub a portion of the residue left after evaporation on a clean dry filter paper.

Observation /Explanation

Propanone dissolve fat/oil in the macadamia nuts. Propanone is more volatile (lower boiling point) than oil/fat. In sunlight/solar energy, propanone evaporate/vapourize leaving oil/fat (has a higher boiling point). Any seed like corn, wheat, rice, soya bean may be used instead of macadamia seed. When oil/fat is rubbed/ smeared on an opaque paper, it becomes translucent.

(j) Crystallization

Crystallization is the process of using solubility of a solute/solid to obtain the solute/solid crystals from a saturated solution by cooling or heating the solution.

A crystal is the smallest regular shaped particle of a solute. Every solute has unique shape of its crystals.

Some solutions form crystals when heated. This is because less solute dissolve at higher temperature. Some other solutions form crystals when cooled. This is because less solute dissolve at lower temperature.

Experiment; To crystallize copper(II)sulphate(VI)solution



Procedure:

Place about one spatula full of hydrated copper sulphate(VI) crystals into 200cm³ of distilled water in a beaker. Stir. Continue adding a little more of the hydrated copper sulphate (VI) crystals and stirring until no more dissolve. Decant/filter. Cover the filtrate with a filter paper. Pierce and make small holes on the filter paper cover. Preserve the experiment for about seven days.

Observation/Explanation

Large blue crystals formed

When hydrated copper(II)sulphate crystals are placed in water, they dissolve to form copper(II)sulphate solution. After some days water slowly evaporate leaving large crystals of copper(II)sulphate. If the mixture is heated to dryness, small crystals are formed.

Physical/Temporary and Chemical changes

A physical/temporary change is one which **no new** substance is formed and is **reversible** back to original.

A chemical/permanent change is one which **a new** substance is formed and is **irreversible** back to original.

The following experiments illustrates physical and chemical changes

(a)Heating ice

Place about 10g of pure ice in a beaker. Determine its temperature.Record it at time “0.0” in the table below. Heat the ice on a strong Bunsen flame and determine its temperature after every 60seconds/1minute to complete the table below:

Time/minutes	0	1	2	3	4	5	6	7	8
Temperature (°C)	-2	0	0	40	80	90	95	95	96

Plot a graph of time against Temperature(y-axes)



Explain the shape of your graph

Melting/freezing/fusion/solidification and **boiling /vaporization /evaporation** are the two physical processes.

Melting /freezing point of pure substances is fixed /constant.

The boiling point of pure substance depend on **external** atmospheric **pressure**.

Melting/fusion is the physical change of a **solid** to **liquid**.

Freezing is the physical change of a **liquid** to **solid**.

Melting/freezing/fusion/solidification are therefore two **opposite** but **same** reversible physical processes i.e

A (s) A(l)

Boiling/vaporization/evaporation is the physical change of a **liquid** to **gas**.

Condensation/ liquidification is the physical change of **gas** to **liquid**.

Boiling/vaporization/evaporation and condensation/ liquidification are therefore two **opposite** but **same** reversible physical processes i.e

B (l) B(g)

Practically

(i) Melting/liquidification/fusion involves **heating** a solid to **weaken** the strong bonds holding the solid particles together.

Solids are made up of very strong bonds holding the particles **very close** to each other (**Kinetic Theory of matter**).

On heating these particles gain energy/heat from the surrounding heat source to form a liquid with **weaker** bonds holding the particles close together but with some degree of **freedom**.

(ii)Freezing/fusion/solidification involves cooling a liquid to reform /rejoin the very strong bonds to hold the particles **very close** to each other as solid and thus lose their degree of **freedom** (**Kinetic Theory of matter**).

Freezing /fusion / solidification is an **exothermic** ($-\Delta H$)process that require particles holding the liquid together to lose energy to the surrounding.

(iii)Boiling/vaporization/evaporation involves **heating** a liquid to completely **break/free** the bonds holding the liquid particles together.

Gaseous particles have high degree of **freedom** (**Kinetic Theory of matter**).



Boiling /vaporization / evaporation is an **endothermic** ($+\Delta H$) process that require/absorb energy from the surrounding.

(iv) Condensation/liquidification is **reverse** process of boiling /vaporization / evaporation.

It involves gaseous particles losing energy to the surrounding to form a liquid.



INTRODUCTION TO ACIDS, BASES AND INDICATORS

1. In a school laboratory:

(i) An **acid** may be defined as a substance that turn litmus **red**.

(ii) A **base** may be defined as a substance that turn litmus **blue**.

Litmus is a lichen found mainly in West Africa. It changes its colour depending on whether the solution it is in, is basic/alkaline or acidic. It is thus able to identify/show whether another substance is an acid, base or neutral.

(iii) An indicator is a substance that shows whether another substance is a base/alkaline, acid or neutral.

2. Common naturally occurring acids include:

Name of acid	Occurrence
1. Citric acid	Found in ripe citrus fruits like passion fruit/oranges/lemon
2. Tartaric acid	Found in grapes/baking powder/health salts
3. Lactic acid	Found in sour milk
4. Ethanoic acid	Found in vinegar
5. Methanoic acid	Present in ants, bees stings
6. Carbonic acid	Used in preservation of fizzy drinks like coke, Lemonade, Fanta
7. Butanoic acid	Present in cheese
8. Tannic acid	Present in tea

3. Most commonly used acids found in a school laboratory are not naturally occurring. They are manufactured. They are called **mineral acids**.

Common mineral acids include:

Name of mineral acid	Common use
----------------------	------------



Hydrochloric acid (HCl)	Used to clean/pickling surface of metals Is found in the stomach of mammals/human beings
Sulphuric(VI) acid (H ₂ SO ₄)	Used as acid in car battery, making battery, making fertilizers
Nitric(V)acid (HNO ₃)	Used in making fertilizers and explosives

4. Mineral acids are manufactured to very high concentration. They are **corrosive** (causes painful wounds on contact with the skin) and attack/reacts with garments/clothes/metals.

In a school laboratory, they are mainly used when added a lot of water. This is called **diluting**. Diluting ensures the concentration of the acid is safely low.

5. Bases are opposite of acids. Most bases do not dissolve in water.

Bases which dissolve in water are called **alkalis**.

Common alkalis include:

Name of alkali	Common uses
Sodium hydroxide (NaOH)	Making soaps and detergents
Potassium hydroxide(KOH)	Making soaps and detergents
Ammonia solution(NH ₄ OH)	Making fertilizers, softening hard water

Common bases (which are not alkali) include:

Name of base	Common name
Magnesium oxide/hydroxide	Anti acid to treat indigestion
Calcium oxide	Making cement and neutralizing soil acidity

6. Indicators are useful in identifying substances which look-alike. An acid-base indicator is a substance used to identify whether another substance is alkaline or acidic.



An acid-base indicator works by changing to different colours in neutral, acidic and alkaline **solutions/dissolved** in water.

Experiment: To prepare simple acid-base indicator

Procedure

(a) Place some flowers petals in a mortar. Crush them using a pestle. Add a little sand to assist in crushing.

Add about 5cm³ of propanone/ethanol and carefully continue grinding.

Add more 5cm³ of propanone/ethanol and continue until there is enough extract in the mortar.

Filter the extract into a clean 100cm³ beaker.

(b) Place 5cm³ of filtered wood ash, soap solution, ammonia solution, sodium hydroxide, hydrochloric acid, distilled water, sulphuric(VI)acid, sour milk, sodium chloride, toothpaste and calcium hydroxide into separate test tubes.

(c) Put about three drops of the extract in (a) to each test tube in (b). Record the observations made in each case.

Sample observations

Solution mixture	Colour on adding indicator extract	Nature of solution
wood ash	green	Base/alkaline
soap solution	green	Basic/alkaline
ammonia solution	green	Basic/alkaline
sodium hydroxide	green	Basic/alkaline
hydrochloric acid	red	Acidic
distilled water	orange	Neutral
sulphuric(VI)acid	red	Acidic
sour milk	green	Basic/alkaline
sodium chloride	orange	Neutral



toothpaste	green	Basic/alkaline
calcium hydroxide	green	Basic/alkaline
Lemon juice	red	Acidic

The plant extract is able to differentiate between solutions by their nature. It is changing to a similar colour for similar solutions.

(i) Since lemon juice is a known acid, then sulphuric(VI) and hydrochloric acids are similar in nature with lemon juice because the indicator shows similar colours. They are acidic in nature.

(ii) Since sodium hydroxide is a known base/alkali, then the green colour of indicator shows an alkaline/basic solution.

(iii) Since pure water is neutral, then the orange colour of indicator shows neutral solutions.

7. In a school laboratory, commercial indicators are used. A commercial indicator is cheap, readily available and easy to store. Common indicators include: Litmus, phenolphthalein, methyl orange, screened methyl orange, bromothymol blue.

Experiment:

Using commercial indicators to determine acidic, basic/alkaline and neutral solutions

Procedure

Place 5cm³ of the solutions in the table below. Add three drops of litmus solution to each solution.

Repeat with phenolphthalein indicator, methyl orange, screened methyl orange and bromothymol blue.

Sample results

Substance/ solution	Indicator used				
	Litmus	Phenolphthalein	Methyl orange	Screened	Bromothymol



				methyl orange	blue
wood ash	Blue	Pink	Yellow	Orange	Blue
soap solution	Blue	Pink	Yellow	Orange	Blue
ammonia solution	Blue	Pink	Yellow	Orange	Blue
sodium hydroxide	Blue	Pink	Yellow	Orange	Blue
hydrochloric acid	Red	Colourless	Red	Purple	Orange
distilled water	Colourless	Colourless	Red	Orange	Orange
sulphuric(VI)acid	Red	Colourless	Red	Purple	Orange
sour milk	Blue	Pink	Yellow	Orange	Blue
sodium chloride	Colourless	Colourless	Red	Orange	Orange
toothpaste	Blue	Pink	Yellow	Orange	Blue
calcium hydroxide	Blue	Pink	Yellow	Orange	Blue
Lemon juice	Red	Colourless	Red	Purple	Orange

From the table above, then the colour of indicators in different solution can be summarized.

Indicator	Colour of indicator in		
	Acid	Base/alkali	Neutral
Litmus paper/solution	Red	Blue	Colourless
Methyl orange	Red	Yellow	Red
Screened methyl orange	Purple	Orange	Orange
Phenolphthalein	Colourless	Purple	Colourless



Bromothymol blue	Orange	Blue	Orange
------------------	--------	------	--------

The universal indicator

The universal indicator is a mixture of other indicator dyes. The indicator uses the pH scale. The pH scale shows the **strength** of bases and acids. The pH scale ranges from 1-14. These numbers are called **pH values**:

- (i) pH values 1,2,3 shows a substance is **strongly acid**
- (ii) pH values 4,5,6 shows a substance is a **weakly acid**
- (iii) pH value 7 shows a substance is a **neutral**
- (iv) pH values 8,9,10,11 shows a substance is a **weak base/alkali**.
- (v) pH values 12,13,14 shows a substance is a strong **base/alkali**

The pH values are determined from a pH chart. The pH chart is a multicoloured paper with each colour corresponding to a pH value. i.e

- (i) **red** correspond to pH 1,2,3 showing strongly acidic solutions.
- (ii) **Orange/ yellow** correspond to pH 4,5,6 showing weakly acidic solutions.
- (iii) **Green** correspond to pH 7 showing neutral solutions.
- (iv) **Blue** correspond to pH 8,9,10,11 showing weakly alkaline solutions.
- (v) **Purple/dark blue** correspond to pH 12,13,14 showing strong alkalis.

The universal indicator is available as:

- (i) universal indicator **paper/pH paper**
- (ii) universal indicator **solution**.

When determining the pH of a unknown solution using

(i) pH paper then the pH paper is dipped into the unknown solution. It changes/turn to a certain colour. The new colour is marched/compared to its corresponding one on the pH chart to get the pH value.

(ii) universal indicator **solution** then about 3 drops of the universal indicator **solution** is added into about 5cm³ of the unknown solution in a test tube. It changes/turn to a



certain colour. The new colour is marched/compared to its corresponding one on the pH chart to get the pH value.

Experiment: To determine the pH value of some solutions

(a) Place 5cm³ of filtered wood ash, soap solution, ammonia solution, sodium hydroxide, hydrochloric acid, distilled water, sulphuric(VI) acid, sour milk, sodium chloride, toothpaste and calcium hydroxide into separate test tubes.

(b) Put about three drops of universal indicator solution or dip a portion of a piece of pH paper into each. Record the observations made in each case.

(c) Compare the colour in each solution with the colours on the pH chart provided. Determine the pH value of each solution.

Sample observations

Solution mixture	Colour on the pH paper/adding universal indicator	pH value	Nature of solution
wood ash	Blue	8	Weakly alkaline
soap solution	Blue	8	Weakly alkaline
ammonia solution	green	8	Weakly alkaline
sodium hydroxide	Purple	14	Strongly alkaline
hydrochloric acid	red	1	Strongly acidic
distilled water	green	7	Neutral
sulphuric(VI) acid	red	1	Strongly acidic
sour milk	blue	9	Weakly alkaline
sodium chloride	green	7	Neutral
toothpaste	Blue	10	Weakly alkaline



calcium hydroxide	Blue	11	Weakly alkaline
Lemon juice	Orange	5	Weakly acidic

Note

1. All the mineral acids Hydrochloric, sulphuric(VI) and nitric(V) acids are strong acids
2. Two alkalis/soluble bases, sodium hydroxide and potassium hydroxide are strong bases/alkali. Ammonia solution is a weak base/alkali. All other bases are weakly alkaline.
3. Pure/deionized water is a neutral solution.
4. Common salt/sodium chloride is a neutral salt.
5. When an acid and an alkali/base are mixed, the final product has pH 7 and is neutral.

Properties of acids

(a) Physical properties of acids

1. Acids have a characteristic sour taste
2. Most acids are colourless liquids
3. Mineral acids are odourless. Organic acids have characteristic smell
4. All acids have pH less than 7
5. All acids turn blue litmus paper red, methyl orange red and phenolphthalein colourless.
6. All acids dissolve in water to form an acidic solution. Most do not dissolve in organic solvents like propanone, kerosene, tetrachloromethane, petrol.

(b) Chemical properties of acids.

1. Reaction with metals

All acids react with reactive metals to form a salt and produce/evolve hydrogen gas.

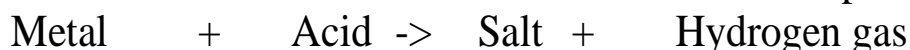

Experiment : reaction of metals with mineral acids.

(a) Place 5cm³ of dilute hydrochloric acid in a small test tube. Add 1cm length of polished magnesium ribbon. Stopper the test tube using a thumb. Light a wooden splint. Place the burning splint on top of the stoppered test tube. Release the thumb stopper. Record the observations made.

(b) Repeat the procedure in (a) above using Zinc granules, iron filings, copper turnings, aluminium foil in place of Magnesium ribbon

(c) Repeat the procedure in (a) then (b) using dilute sulphuric(VI) acid in place of dilute hydrochloric acid.

Sample observations

- (i) effervescence/bubbles produced/fizzing in all cases except when using copper
- (ii) colourless gas produced in all cases except when using copper
- (iii) gas produced extinguishes a burning wooden splint with an explosion/pop sound.

Explanation

Some metals react with dilute acids, while others do not. Metals which react with acids produce bubbles of hydrogen gas. Hydrogen gas is a colourless gas that extinguishes a burning splint with a pop sound. This shows acids contain hydrogen gas.

This hydrogen is displaced/removed from the acids by some metals like Magnesium, Zinc, aluminium, iron and sodium.

Some other metals like copper, silver, gold, platinum and mercury are not reactive enough to displace/remove the hydrogen from dilute acids.

Chemical equations

1. Magnesium + Hydrochloric acid -> Magnesium chloride + Hydrogen



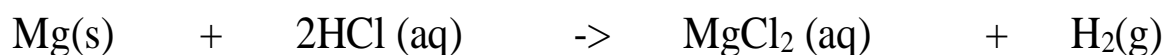

2. Zinc + Hydrochloric acid -> Zinc chloride + Hydrogen

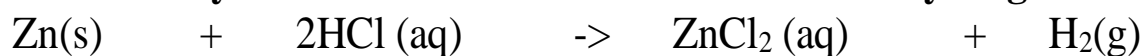

3. Iron + Hydrochloric acid -> Iron(II) chloride + Hydrogen



4. Aluminium + Hydrochloric acid -> Aluminium chloride + Hydrogen

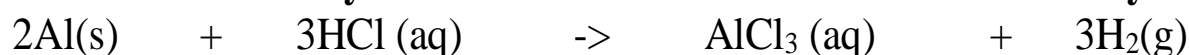

5. Magnesium + Sulphuric(VI)acid -> Magnesium sulphate(VI) + Hydrogen

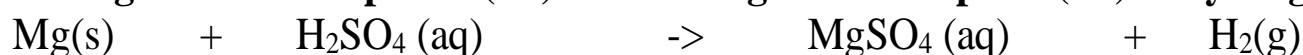

6. Zinc + Sulphuric(VI)acid -> Zinc sulphate(VI) + Hydrogen

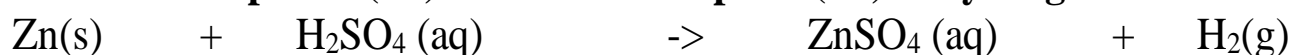

7. Iron + Sulphuric(VI)acid -> Iron(II) sulphate(VI) + Hydrogen



8. Aluminium + Sulphuric(VI)acid -> Aluminium sulphate(VI) + Hydrogen

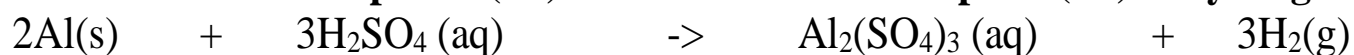

2. Reaction of metal carbonates and hydrogen carbonates with mineral acids.

All acids react with carbonates and hydrogen carbonates to form a salt, water and produce /evolve carbon (IV)oxide gas.

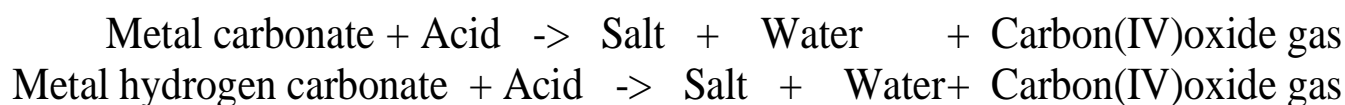

Experiment : reaction of metal carbonates and hydrogen carbonates with mineral acids.

(a) Place 5cm³ of dilute hydrochloric acid in a small test tube. Add half spatula full of sodium carbonate. Stopper the test tube using a cork with delivery tube directed into lime water. Record the observations made. Test the gas also with burning splint.

(b) Repeat the procedure in (a) above using Zinc carbonate, Calcium carbonate, copper carbonate, sodium hydrogen carbonate, Potassium hydrogen carbonate in place of Sodium carbonate.

(c) Repeat the procedure in (a) then (b) using dilute sulphuric (VI) acid in place of dilute hydrochloric acid.

Set up of apparatus

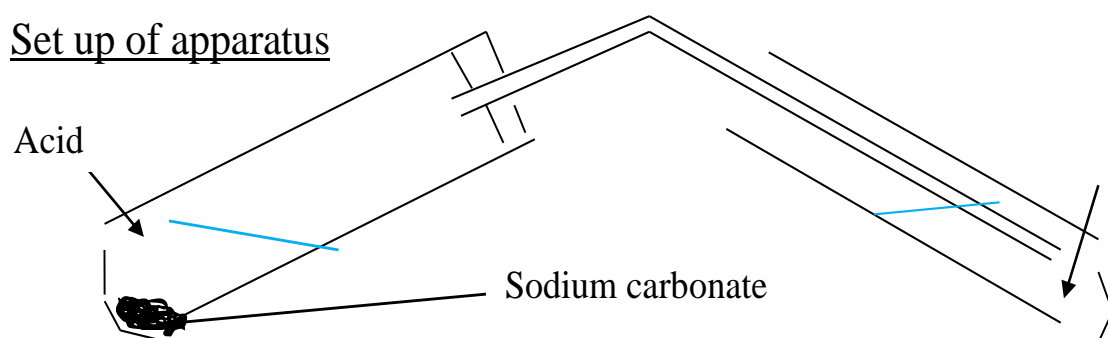

Sample observations

- (i) effervescence/bubbles produced/fizzing in all cases.
- (ii) colourless gas produced in all cases.
- (iii) gas produced forms a white precipitate with lime water.

Explanation

All metal carbonate/hydrogen carbonate reacts with dilute acids to produce bubbles of carbon (IV)oxide gas. Carbon(IV)oxide gas is a colourless gas that extinguishes a

burning splint. When carbon (IV) oxide gas is bubbled in lime water, a white precipitate is formed.

Chemical equations

1. Sodium carbonate + Hydrochloric acid ->



2. Calcium carbonate + Hydrochloric acid ->



3. Magnesium carbonate + Hydrochloric acid ->



4. Copper carbonate + Hydrochloric acid ->



5. Copper carbonate + Sulphuric(VI) acid ->

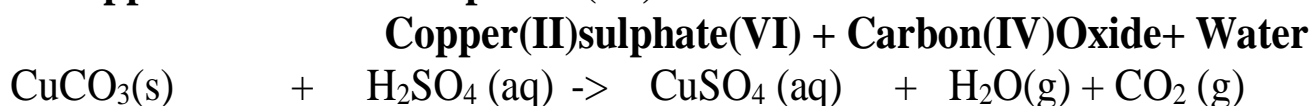

6. Zinc carbonate + Sulphuric(VI) acid ->

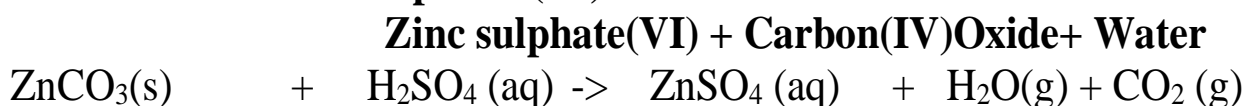

7. Sodium hydrogen carbonate + Sulphuric(VI) acid ->

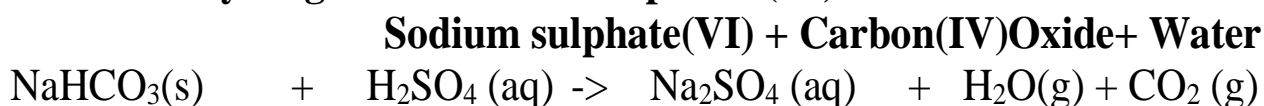

8. Potassium hydrogen carbonate + Sulphuric(VI) acid ->

Potassium sulphate(VI) + Carbon(IV)Oxide+ Water

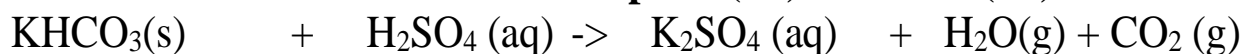

9. Potassium hydrogen carbonate + Hydrochloric acid ->

Potassium chloride + Carbon(IV)Oxide+ Water

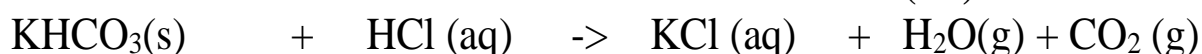

10. Sodium hydrogen carbonate + Hydrochloric acid ->

Sodium chloride + Carbon(IV)Oxide+ Water

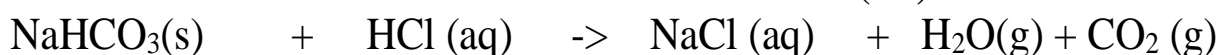

3. Neutralization by bases/alkalis

All acids react with bases to form a salt and water only. The reaction of an acid with metal oxides/hydroxides(bases) to salt and water only is called neutralization reaction.

Since no effervescence/bubbling/fizzing take place during neutralization:

(i) the reaction with alkalis require a suitable indicator. The colour of the indicator changes when all the acid has reacted with the soluble solution of the alkali (metal oxides/ hydroxides).

(ii) excess of the base is added to ensure all the acid reacts. The excess acid is then filtered off.

Experiment 1 : reaction of alkali with mineral acids.



(i) Place about 5cm³ of dilute hydrochloric acid in a boiling tube. Add one drop of phenolphthalein indicator. Using a dropper/teat pipette, add dilute sodium hydroxide dropwise until there is a colour change.

(ii) Repeat the procedure with dilute sulphuric (VI) acid instead of hydrochloric acid.

(iii) Repeat the procedure with potassium hydroxide instead of sodium hydroxide.

Sample observation:

Colour of phenolphthalein change from colourless to **pink** in all cases.

Explanation

Bases/alkalis neutralize acids. Acids and bases/alkalis are colourless. A suitable indicator like phenolphthalein change colour to **pink**, when all the acid has been neutralized by the bases/alkalis. Phenolphthalein change colour **from pink**, to colourless when all the bases/alkalis has been neutralized by the acid.

Chemical equation

Sodium oxide + Hydrochloric acid → Sodium chloride + Water

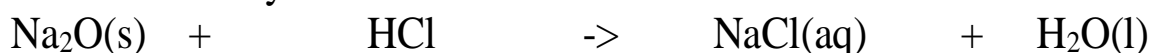

Potassium oxide + Hydrochloric acid → Potassium chloride + Water



Sodium hydroxide + Hydrochloric acid → Sodium chloride + Water



Ammonia solution + Hydrochloric acid → Ammonium chloride + Water

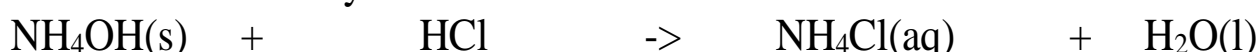

Potassium hydroxide + Hydrochloric acid → Potassium chloride + Water



Sodium hydroxide + sulphuric(VI) acid → Sodium sulphate(VI) + Water

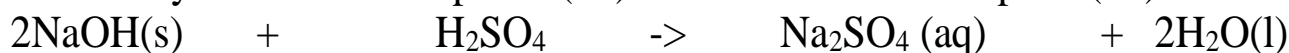

Potassium hydroxide + sulphuric(VI) acid → Potassium sulphate(VI) + Water



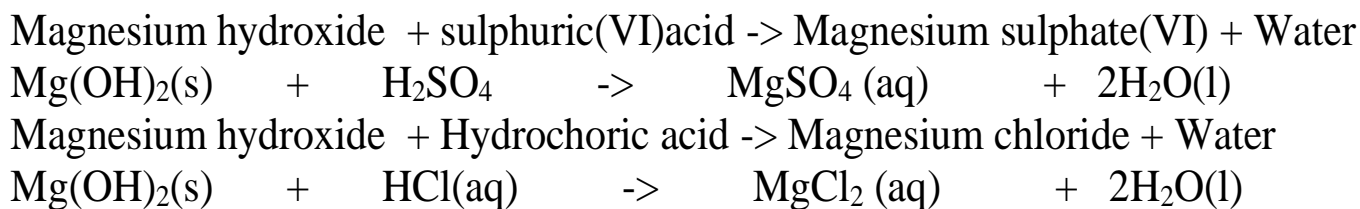
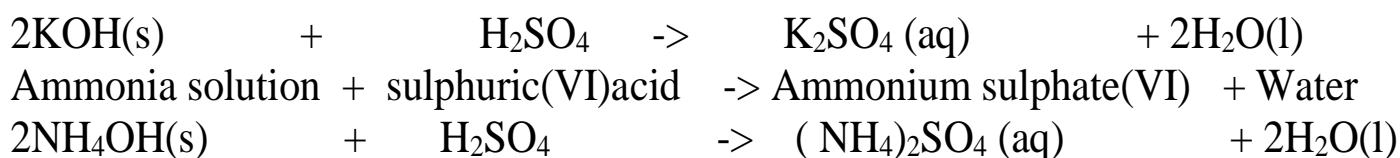

Air, Oxygen & Combustion

A. THE ATMOSPHERE .

1. The atmosphere is made up of air. Air is a mixture of colourless, odourless gases which is felt as wind (air in motion). All living things breathe in air for respiration. Plants use air for respiration and photosynthesis.

2. The main gases present in the atmosphere/air:

Gas	Approximate % composition by volume
Nitrogen	78.0



Oxygen	21.0
Carbon(IV)oxide	0.03
Noble gases	1.0
Water vapour	Vary from region

3. The following experiments below shows the presence and composition of the gases in air/atmosphere

(a) To find the composition of air supporting combustion using a candle stick

Procedure

Measure the length of an empty gas jar M_1 . Place a candle stick on a petri dish. Float it on water in a basin/trough. Cover it with the gas jar. Mark the level of the water in the gas jar M_2 . Remove the gas jar. Light the candle stick. Carefully cover it with the gas jar. Observe for two minutes. Mark the new level of the water M_3 .

Set up of apparatus

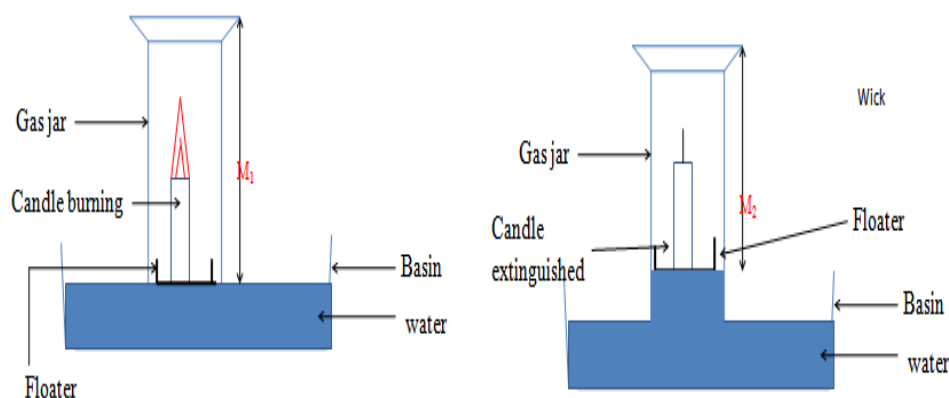

Sample observations

Candle continues to burn then extinguished/goes off
 Level of water in the gas jar rises after igniting the candle

Length of empty gas jar = $M_1 = 14\text{cm}$

Length of gas jar **without** water before igniting candle = $M_2 = 10\text{ cm}$

Length of gas jar **with** water before igniting candle = $M_1 - M_2 = 14 - 10 = 4\text{ cm}$

Length of gas jar **with** water after igniting candle = $M_3 = 8\text{ cm}$

Length of gas jar **without** water after igniting candle = $M_1 - M_3 = 14 - 8 = 6\text{ cm}$

Explanation

Candle burns in air. In a closed system (vessel), the candle continues to burn using the part of air that supports burning/combustion. This is called the **active part of air**. The candle goes off/extinguished when all the active part of air is used up. The level of the water rises to occupy the space / volume occupied by the used active part of air.

The experiment is better when very dilute **sodium/potassium hydroxide** is used instead of water. Dilute Potassium/ sodium hydroxide absorbs **Carbon(IV)oxide** gas that comes out from burning/combustion of candle stick.

From the experiment above the % composition of the:

(i) active part of air can be calculated:

$$\frac{M_2 - M_3}{M_2} \times 100\% \Rightarrow \frac{10 - 8}{10} \times 100\% = 20\%$$

(ii) inactive part of air can be calculated:

$$100\% - 20\% = 80\% \quad // \quad \frac{M_3}{M_2} \Rightarrow \frac{8}{10} \times 100\% = 80\%$$

(b) To find the composition of active part of air using heated copper turnings.

Procedure

Clamp a completely packed/filled open ended glass tube with copper turnings. Seal the ends with glass/cotton wool.

Label two graduated syringes as "A" and "B". Push out air from syringe "A". Pull in air into syringe "B".



Attach both syringe “A” and “B” on opposite ends of the glass tube.

Determine and record the volume of air in syringe “B” V_1 .

Heat the glass tube strongly for about three minutes.

Push all the air slowly from syringe “B” to syringe “A” as heating continues. Push all the air slowly from syringe “A” back to syringe “B” and repeatedly back and forth.

After about ten minutes, determine the new volume of air in syringe “B” V_2

Set up of apparatus

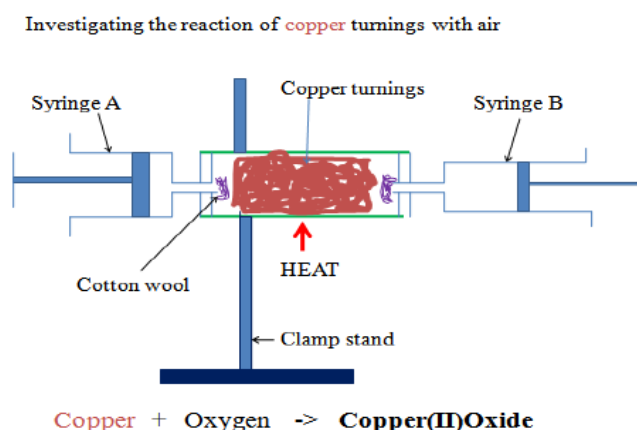

Sample observations

Colour change from brown to black

Volume of air in syringe “B” before heating $V_1 = 158.0\text{cm}^3$

Volume of air in syringe “B” after heating $V_2 = 127.2\text{cm}^3$

Volume of air in syringe “B” used by copper $V_1 - V_2 = 30.8\text{cm}^3$

Sample questions

1. What is the purpose of

(i) glass/cotton wool

To prevent/stop copper turnings from being blown into the syringe/out of the glass tube

(ii) passing air through the glass tube repeatedly

To ensure all the active part of air is used up

(iii) passing air through the glass tube slowly

To allow enough time of contact between the active part of and the heated copper turnings.

2. State and explain the observations made in the glass tube.

Colour change from brown to black

Brown copper metal reacts with the active part of air/oxygen to form black copper(II)oxide.

Chemical equation

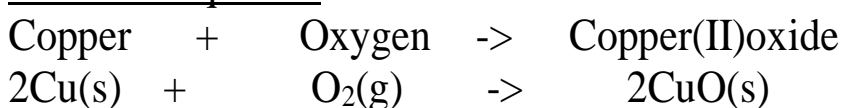

The reaction reduces the amount/volume of oxygen in syringe “B” leaving the inactive part of air. Copper only react with oxygen when heated.

3. Calculate the % of

(i) active part of air

$$\% \text{ active part of air} = \frac{V_1 - V_2}{V_1} \times 100\% \Rightarrow \frac{30.8\text{cm}^3}{158.0\text{cm}^3} \times 100\% = \underline{\underline{19.493\%}}$$

(ii) inactive part of air

Method 1

$$\% \text{ inactive part of air} = \frac{V_2}{V_1} \times 100\% \Rightarrow \frac{127.2\text{cm}^3}{158.0\text{cm}^3} \times 100\% = \underline{\underline{80.506\%}}$$

Method 2

$$\begin{aligned} \% \text{ inactive part of air} &= 100\% - \% \text{ active part of air} \\ &\Rightarrow 100\% - 19.493\% = \underline{\underline{80.507\%}} \end{aligned}$$

4. The % of active part of air is theoretically higher than the above while % of inactive part of air is theoretically lower than the above. Explain.



Not all the active part of air reacted with copper

5.State the main gases that constitute:

(a)active part of air.

Oxygen

(b) inactive part of air

Nitrogen, carbon(IV)oxide and noble gases

6.If the copper turnings are replaced with magnesium shavings the % of active part of air obtained is extraordinary very high. Explain.

Magnesium is more reactive than copper. The reaction is highly exothermic. It generates enough heat for magnesium to react with both oxygen and nitrogen in the air.

A white solid/ash mixture of Magnesium oxide and Magnesium nitride is formed. This considerably reduces the volume of air left after the experiment.

Chemical equation

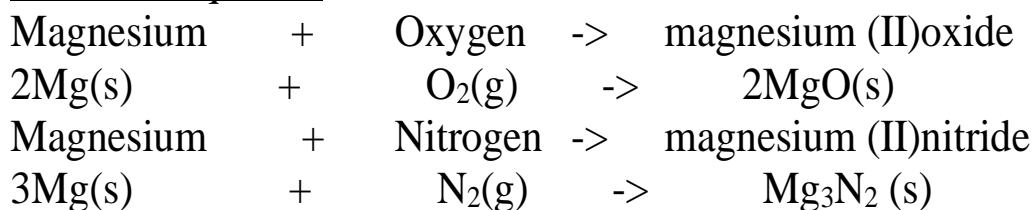

(c)To find the composition of active part of air using alkaline pyrogallol.

Procedure

Measure about 2cm³ of dilute sodium hydroxide into a graduated gas jar. Record the volume of the graduated cylinder V_1 .

Place about two spatula end full of pyrogallol/1,2,3-trihydroxobenzene into the gas jar. Immediately place a cover slip firmly on the mouth of the gas jar. Swirl thoroughly for about two minutes.



Invert the gas jar in a trough/basin containing water. Measure the volume of air in the gas jar V_2

Sample observations

Colour of pyrogallol/1,2,3-trihydroxobenzene change to **brown**.

Level of water in gas jar rises when inverted in basin/trough.

Volume of gas jar /air in gas jar $V_1 = 800\text{cm}^3$

Volume of gas jar /air in gas jar after shaking with **alkaline** pyrogallol/1,2,3-trihydroxobenzene $V_2 = 640\text{ cm}^3$

Sample questions

1. Which gas is absorbed by alkaline pyrogallol/1,2,3-trihydroxobenzene

Oxygen

2. Calculate the

(i) % of active part of air

$$V_1 \frac{V_1 - V_2 \times 100\%}{800\text{cm}^3} \Rightarrow \frac{(800\text{cm}^3 - 640\text{ cm}^3) \times 100\%}{800\text{cm}^3} = \underline{\underline{20\%}}$$

(ii) % of inactive part of air

$$V_1 \frac{V_2 \times 100\%}{800\text{cm}^3} \Rightarrow \frac{640\text{ cm}^3 \times 100\%}{800\text{cm}^3} = \underline{\underline{80\%}}$$

(d) To establish the presence of carbon(IV)oxide in air using lime water

Pass tap water slowly into an empty flask as in the set up below



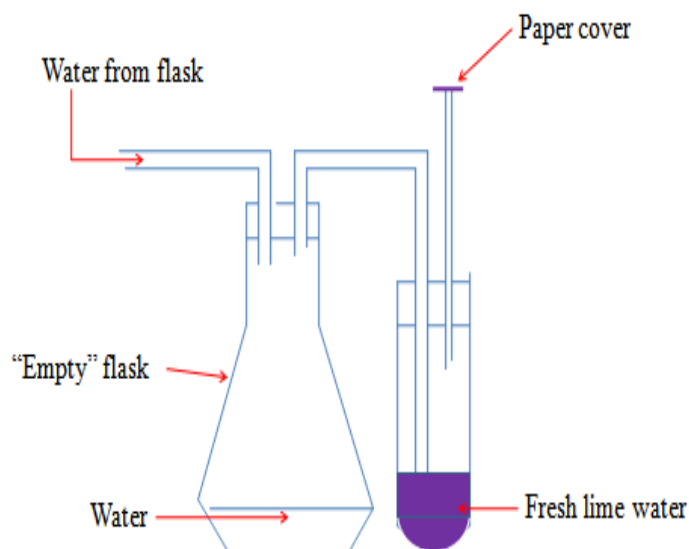

Sample observation questions

1. What is the purpose of paper cover?

To ensure no air enters into the lime water.

2. What happens when water enters the flask?

It forces the air from the flask into the lime water.

3. What is observed when the air is bubbled in the lime water

A white precipitate is formed. The white precipitate dissolves on prolonged bubbling of air.

4. (a) Identify the compound that form:

(i) lime water

Calcium hydroxide / $\text{Ca}(\text{OH})_2$

(ii) white precipitate

Calcium carbonate / CaCO_3

(iii) when the white precipitate dissolves

Calcium hydrogen carbonate / CaHCO_3

(b) Write the chemical equation for the reaction that take place when:

(i) white precipitate is formed

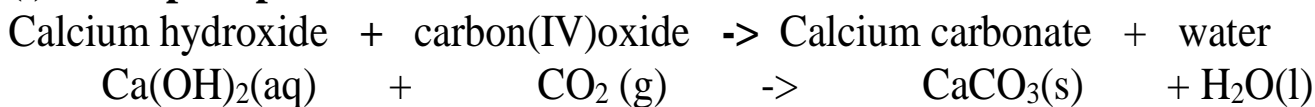

(ii) white precipitate dissolves

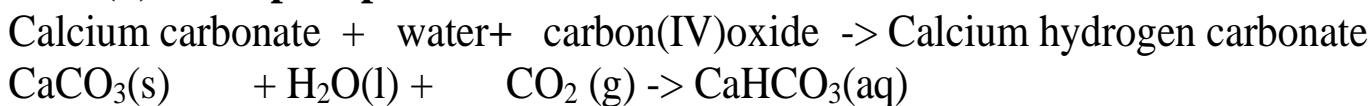

5. State the chemical test for the presence of carbon (IV)oxide gas based on 4(a) and (b)above:

Carbon(IV)oxide forms a white precipitate with lime water that dissolves in excess of the gas.

6. State the composition of carbon(IV)oxide gas by volume in the air.

About 0.03% by volume

B.OXYGEN.

a) Occurrence.

- 1.Fifty 50% of the earths crust consist of Oxygen combined with other elements e.g.oxides of metals
- 2.About 70% of the earth is water made up of Hydrogen and Oxygen.
- 3.About 20% by volume of the atmospheric gases is Oxygen that form the active part of air.

b)School laboratory preparation.

Oxygen was first prepared in 1772 by Karl Scheele and later in 1774 by Joseph Priestly.It was Antony Lavoisier who gave it the name "Oxygen"

Procedure

Method 1: Using Hydrogen peroxide

Half fill a trough/basin with tap water. Place a bee hive shelf/stand into the water.



Completely fill the a gas jar with water and invert in onto the bee hive shelf/stand. Clamp a round bottomed flask and set up the apparatus as below.

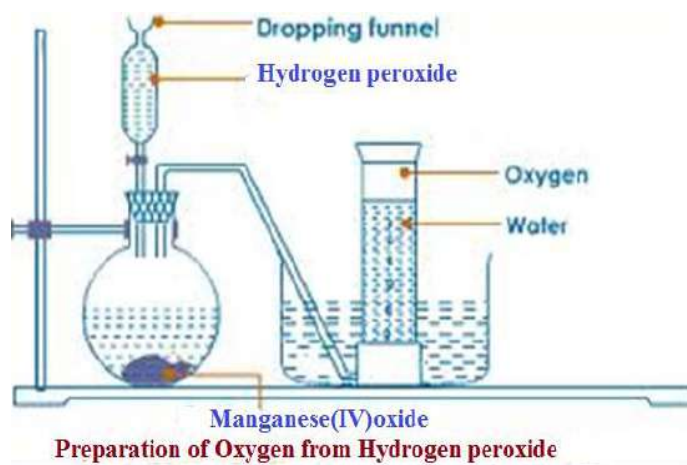

Collect several gas jars of Oxygen covering each sample.

Sample observation questions

1. What is observed when the hydrogen peroxide is added into the flask

Rapid effervescence/bubbling/fizzing

2. Describe the colour and smell of the gas

Colourless and odourless.

3.(a) Name the method of gas collection used.

-Over water

-Upward delivery

-Down ward displacement of water

(b) What property of Oxygen make it to be collected using the method above

-Slightly soluble in water

4. What is the purpose of manganese(IV)oxide?

Manganese(IV)oxide is **catalyst**.

A catalyst is a substance that speeds up the rate of a chemical reaction but remain chemically unchanged at the end of the reaction.

Hydrogen peroxide decomposes slowly to form water and Oxygen gas.

A little Manganese(IV)oxide speeds up the rate of decomposition by **reducing** the time taken for a given volume of Oxygen to be produced.

5. Write the equation for the reaction.

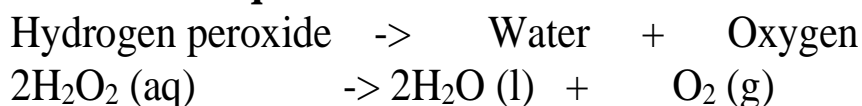

6. Lower a glowing splint slowly into a gas jar containing Oxygen gas. State what is observed.

The glowing splint relights/rekindles

Oxygen relights/rekindles a glowing splint. This is the confirmatory test for the presence of Oxygen gas

Method 1: Using Sodium peroxide

Half fill a trough/basin with tap water. Add four drops of phenolphthalein indicator.

Place a bee hive shelf/stand into the water.

Completely fill a gas jar with water and invert in onto the bee hive shelf/stand.

Clamp a round bottomed flask and set up the apparatus as below.



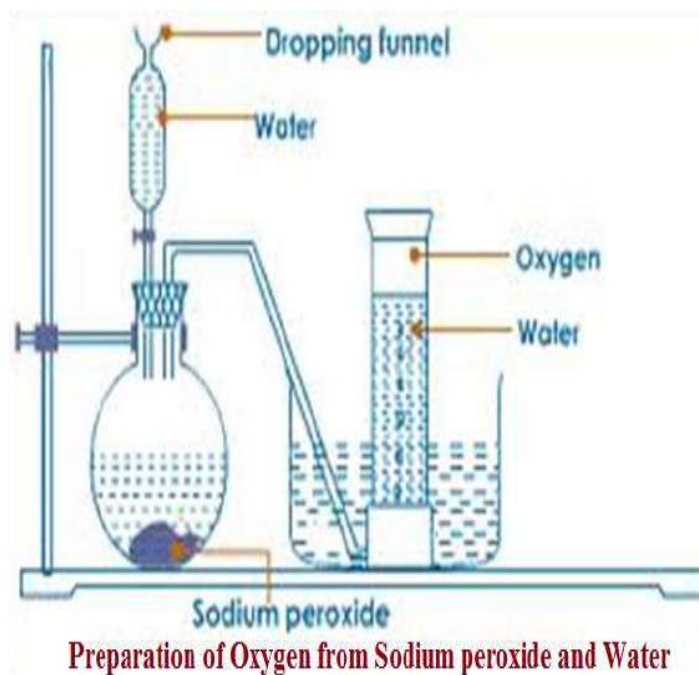

Collect several gas jars of Oxygen covering each sample.

Sample observation questions

1. What is observed when water is added

(i) into the flask containing sodium peroxide

Rapid effervescence/bubbling/fizzing

(ii) phenolphthalein

Remains colourless / Phenolphthalein indicator is colourless in neutral solution

2. Describe the colour and smell of the gas

Colourless and odourless.

3.(a) Name the method of gas collection used.

-Over water. Oxygen is slightly soluble in water.

4. Test the gas by lowering a glowing splint slowly into a gas jar containing the prepared sample.

The glowing splint relights/rekindles. This confirms the presence of Oxygen gas

5. Write the equation for the reaction.

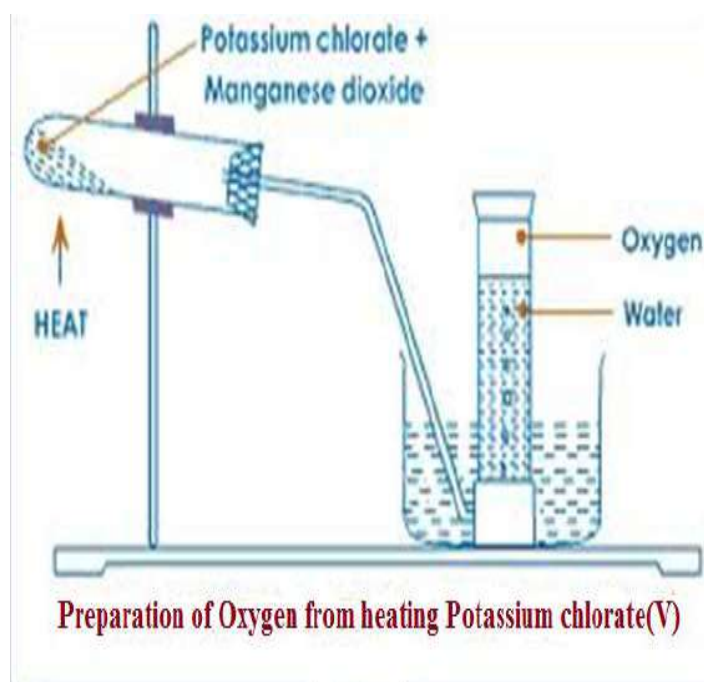
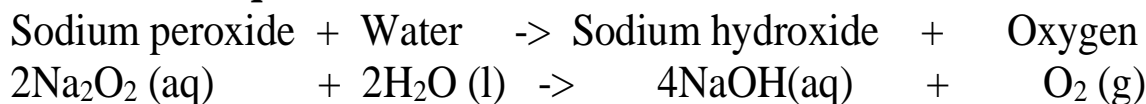

1. Test the gas by lowering a glowing splint slowly into a gas jar containing the prepared sample.

The glowing splint relights/rekindles.

This confirms the presence of Oxygen gas

2. Write the equation for the reaction.

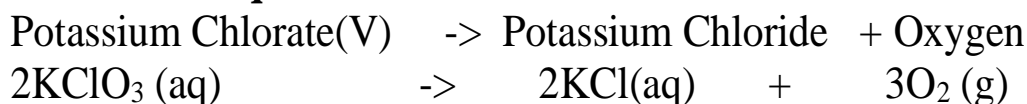

3. What is the purpose of manganese(IV)oxide?

Manganese(IV)oxide is **catalyst**.

A catalyst is a substance that speeds up the rate of a chemical reaction but remain chemically unchanged at the end of the reaction.

Potassium Chlorate(V) decomposes slowly to form potassium chloride and Oxygen gas.

A little Manganese(IV)oxide speeds up the rate of decomposition by **reducing** the time taken for a given volume of Oxygen to be produced.

(c) Uses of Oxygen

1. Oxygen is put in cylinders for use where natural supply is not sufficiently enough. This is mainly in:

(i) Mountain climbing/Mountaineering-at high altitudes, the concentration of air/oxygen is low. Mountain climbers must therefore carry their own supply of oxygen for breathing.

(ii) Deep sea diving-Deep sea divers carry their own supply of Oxygen.

(iii) Saving life in hospitals for patients with breathing problems and during anaesthesia.

2. A mixture of oxygen and some other gases produces a flame that is very hot.

(i) **Oxy-acetyline/ethyne** flame is produced when Ethyne/acetylene gas is burnt in pure oxygen. The flame has a temperature of about 3000°C. It is used for **welding /cutting metals**.

(ii) **Oxy-hydrogen** flame is produced when Hydrogen is burn in pure oxygen. The flame has a temperature of about 2000°C. It is used also for **welding /cutting metals**.

3. **Oxy-hydrogen** mixture is used as rocket fuel

4. A mixture of charcoal , petrol and liquid Oxygen is an explosive.

(d) Chemical properties of Oxygen /combustion.



Oxygen is a very reactive non metal. Many elements react with oxygen through burning to form a group of compounds called **Oxides**.

Burning/combustion is the reaction of Oxygen with an element/substances.

Reaction in which a substance is added oxygen is called **Oxidation reaction**.

Burning/combustion is an example of an oxidation reaction.

Most **non metals** burns in Oxygen/air to form an Oxide which in solution / dissolved in water is **acidic** in nature. They turn blue litmus red.e.g. Carbon(IV)oxide/ CO_2 , Nitrogen(IV)oxide/ NO_2 , Sulphur(IV)oxide/ SO_2

Some non metals burns in Oxygen/air to form an Oxide which in solution / dissolved in water is **neutral** in nature. They **don't** turn blue or red litmus. e.g.

Carbon(II)oxide/ CO , Water/ H_2O .

All **metals** burns in Oxygen/air to form an Oxide which in solution/dissolved in water is **basic/alkaline** in nature. They turn red litmus blue.e.g.

Magnesium oxide/ MgO , Sodium Oxide/ Na_2O ,Copper(II)oxide/ CuO

Elements/substances burn **faster** in pure Oxygen than in air.

Air contains the inactive part of air that **slows** the rate of burning of substances/elements.

(i)Reaction of metals with Oxygen/air

The following experiments show the reaction of metals with Oxygen and air.

I. Burning Magnesium

Procedure

(a)Cut a 2cm length piece of magnesium ribbon. Using a pair of tongs introduce it to a Bunsen flame. Remove it when it catches fire. Observe.

Place the products in a beaker containing about 5cm^3 of water. Test the solution/mixture using litmus papers

(b)Cut another 2cm length piece of magnesium ribbon. Using a pair of tongs introduce it to a Bunsen flame. When it catches fire, lower it slowly into a gas jar containing Oxygen.



Place about 5cm³ of water into the gas jar. Test the solution/mixture using litmus papers. Test the solution/mixture using litmus papers

Observations

(a) In air

Magnesium burns with a bright blinding flame in air forming white solid/ash /powder. Effervescence/bubbles/ fizzing Pungent smell of urine. Blue litmus paper remains blue. Red litmus paper turns blue

(b) In pure Oxygen

Magnesium burns **faster** with a very bright blinding flame pure oxygen forming white solid/ash /powder. No effervescence/bubbles/ fizzing. No pungent smell of urine. Blue litmus paper remains blue. Red litmus paper turns blue

Explanation

Magnesium burns in air producing enough heat energy to react with both Oxygen and Nitrogen to form **Magnesium Oxide** and **Magnesium nitride**. Both Magnesium Oxide and Magnesium nitride are white solid/ash /powder.

Chemical equations



Magnesium Oxide dissolves in water to form a basic/alkaline solution of Magnesium hydroxide

Chemical equations

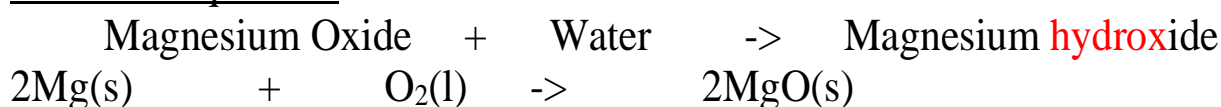

Magnesium Nitride dissolves in water to form a basic/alkaline solution of Magnesium hydroxide and producing **Ammonia gas**. Ammonia is also an alkaline/basic gas that has a pungent smell of urine.

Chemical equations

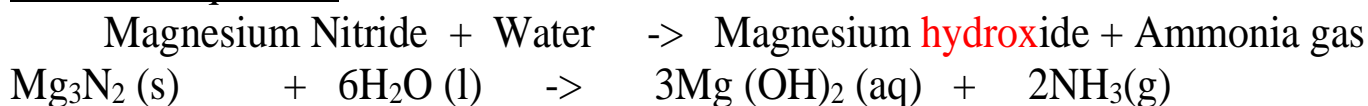

II. Burning Sodium

Procedure

(a) **Carefully** cut a very small piece of sodium . Using a deflagrating spoon introduce it to a Bunsen flame. Remove it when it catches fire. Observe.

Place the products in a beaker containing about 20cm³ of water. Test the solution/mixture using litmus papers

(b) **Carefully** cut another very small piece of sodium. Using a deflagrating spoon introduce it to a Bunsen flame. When it catches fire, lower it slowly into a gas jar containing Oxygen.

Place about 20 cm³ of water into the gas jar. Test the solution/mixture using litmus papers. Test the solution/mixture using litmus papers

Observations

(a) In air

Sodium burns with a **yellow** flame in air forming a **black** solid. Blue litmus paper remains blue. Red litmus paper turns blue

(b) In pure Oxygen

Sodium burns **faster** with a golden **yellow** flame in pure oxygen forming a **yellow** solid. Effervescence/bubbles/ fizzing. Gas produced relights glowing splint. Blue litmus paper remains blue. Red litmus paper turns blue.

Explanation

(a) Sodium burns in air forming black **Sodium Oxide**

Chemical equations





Sodium Oxide dissolves in water to form a basic/alkaline solution of Sodium hydroxide

Chemical equations

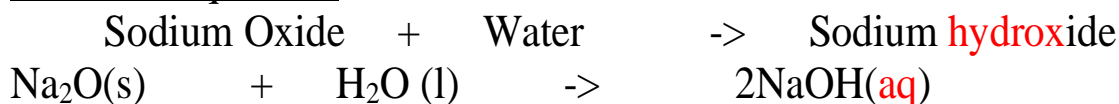

(b) Sodium burns in pure oxygen forming yellow **Sodium peroxide**

Chemical equations

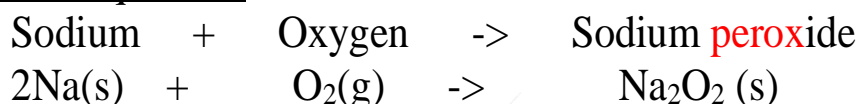

Sodium peroxide dissolves in water to form a basic/alkaline solution of Sodium hydroxide. Oxygen is produced.

Chemical equations

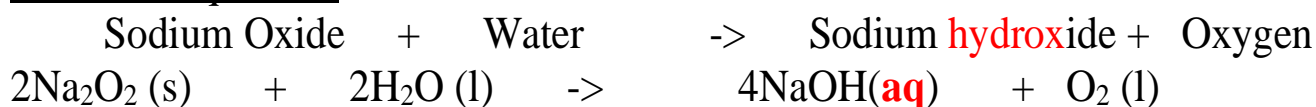

III. Burning Calcium

Procedure

(a) Using a pair of tongs hold the piece of calcium on a Bunsen flame. Observe.

Place the products in a beaker containing about 2cm³ of water. Test the solution/mixture using litmus papers

(b) Using a pair of tongs hold another piece of calcium on a Bunsen flame. Quickly lower it into a gas jar containing Oxygen gas. Observe.

Place about 2cm³ of water. Swirl.

Test the solution/mixture using litmus papers



Observations

(a) In air

Calcium burns with difficulty producing a faint **red** flame in air forming a **white** solid. Blue litmus paper remains blue. Red litmus paper turns blue

(b) In pure Oxygen

Calcium burns with difficulty producing a less faint **red** flame Oxygen forming a **white** solid. Blue litmus paper remains blue. Red litmus paper turns blue

Explanation

(a) Calcium burns in air forming white **calcium Oxide**. Calcium Oxide coat/cover the calcium preventing further burning.

Chemical equations

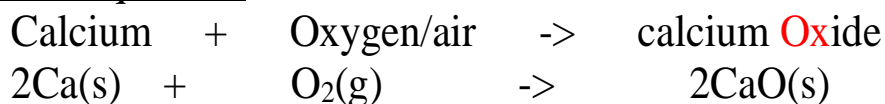

Small amount of Calcium Oxide dissolves in water to form a basic/alkaline solution of Calcium hydroxide. The common name of Calcium hydroxide is **lime water**.

Chemical equations

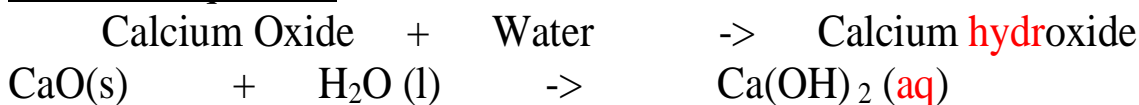

IV. Burning Iron

Procedure

(a) Using a pair of tongs hold the piece of Iron wool/steel wire on a Bunsen flame. Observe.

Place the products in a beaker containing about 2cm³ of water. Test the solution/mixture using litmus papers

(b) Using a pair of tongs hold another piece of Iron wool/steel wire on a Bunsen flame. Quickly lower it into a gas jar containing Oxygen gas. Observe.

Place about 2cm³ of water. Swirl. Test the solution/mixture using litmus papers

Observations

(a) In air



Iron wool/steel wire burns producing a **Orange** flame in air forming a **brown** solid. Blue litmus paper remains blue. Red litmus paper turns faint blue

(b) In pure Oxygen

Iron wool/steel wire burns producing a golden **Orange** flame in Oxygen forming a **Brown** solid. Blue litmus paper remains blue. Red litmus paper turns faint blue

Explanation

(a) Iron burns in air forming brown **Iron(III) Oxide**

Chemical equations

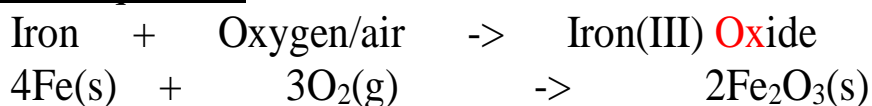

Very small amount of Iron(III)Oxide dissolves in water to form a weakly basic/alkaline **brown** solution of Iron(III) hydroxide.

Chemical equations

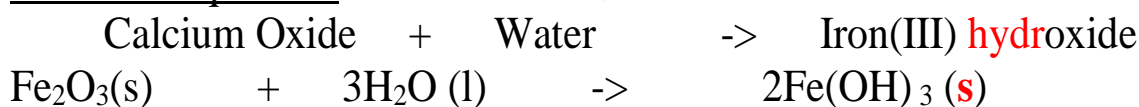

V. Burning Copper

Procedure

(a) Using a pair of tongs hold the piece of copper turnings/shavings on a Bunsen flame.

Observe.

Place the products in a beaker containing about 2cm³ of water. Test the solution/mixture using litmus papers

(b) Using a pair of tongs hold another piece of Copper turnings/shavings on a Bunsen flame. Quickly lower it into a gas jar containing Oxygen gas. Observe.

Place about 2cm³ of water. Swirl. Test the solution/mixture using litmus papers

Observations

(a) In air



Copper turnings/shavings burns with difficulty producing a **green** flame in air forming a **black** solid. Blue litmus paper remains blue. Red litmus paper turns faint blue

(b) In pure Oxygen

Copper turnings/shavings burns less difficulty producing a **green** flame in Oxygen forming a **Brown** solid. Blue litmus paper remains blue. Red litmus paper turns faint blue

Explanation

(a)Copper burns in air forming black **Copper(II) Oxide**

Chemical equations



Very small amount of Copper(II)Oxide dissolves in water to form a weakly basic/alkaline **blue** solution of Copper(II) hydroxide.

Chemical equations

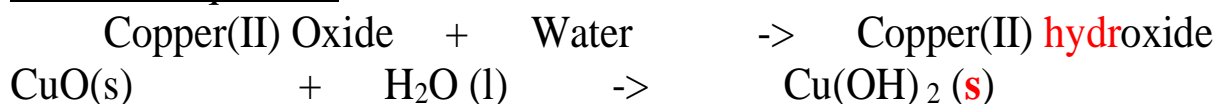

(i)Reaction of non metals with Oxygen/air

The following experiments show the reaction of non metals with Oxygen and air.

I. Burning Carbon

Procedure

(a)Using a pair of tongs hold a dry piece of charcoal on a Bunsen flame.

Observe.

Place the products in a beaker containing about 2cm³ of water. Test the solution/mixture using litmus papers

(b)Using a pair of tongs hold another piece of dry charcoal on a Bunsen flame. Quickly lower it into a gas jar containing Oxygen gas .Observe.

Place about 2cm³ of water. Swirl. Test the solution/mixture using litmus papers



Observations

- Carbon **chars** then burns with a **blue** flame
- Colourless and odourless gas produced
 - Solution formed turn **blue** litmus paper faint **red**.
 - Red** litmus paper remains **red**.

Explanation

Carbon burns in air and faster in Oxygen with a blue non-sooty/non-smoky flame forming Carbon (IV) oxide gas.

Carbon burns in limited supply of air with a blue non-sooty/non-smoky flame forming Carbon (IV) oxide gas.

Carbon (IV) oxide gas dissolve in water to form weak acidic solution of Carbonic (IV)acid.

Chemical Equation

Carbon + Oxygen \rightarrow Carbon(IV)oxide
(excess air/oxygen)



Carbon + Oxygen \rightarrow Carbon(II)oxide
(limited air/oxygen)

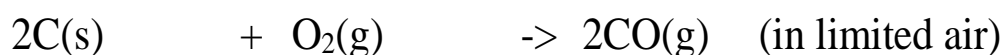

Carbon(IV)oxide + Water \rightarrow Carbonic(IV)acid
 $\text{CO}_2(\text{g}) + \text{H}_2\text{O (l)} \rightarrow \text{H}_2\text{CO}_3 (\text{aq})$ (very weak acid)

II. Burning Sulphur

Procedure

(a)Using a deflagrating spoon place sulphur powder on a Bunsen flame.



Observe.

Place the products in a beaker containing about 3cm³ of water. Test the solution/mixture using litmus papers

(b) Using a deflagrating spoon place sulphur powder on a Bunsen flame. Slowly lower it into a gas jar containing Oxygen gas. Observe.

Place about 5cm³ of water. Swirl. Test the solution/mixture using litmus papers.

Observations

-Sulphur burns with a **blue** flame

-Gas produced that has pungent choking smell

-Solution formed turn **blue** litmus paper faint **red**.

Red litmus paper remains **red**.

Explanation

Sulphur burns in air and faster in Oxygen with a blue non-sooty/non-smoky flame forming Sulphur (IV) oxide gas.

Sulphur (IV) oxide gas dissolve in water to form weak acidic solution of Sulphuric (IV)acid.

Chemical Equation

Sulphur + Oxygen \rightarrow Sulphur(IV)oxide



Sulphur(IV)oxide + Water \rightarrow Sulphuric(IV)acid



III. Burning Phosphorus

Procedure

(a)Remove a small piece of phosphorus from water and using a deflagrating spoon (with a lid cover)place it on a Bunsen flame.

Observe.



Carefully put the burning phosphorus to cover gas jar containing about 3cm³ of water. Test the solution/mixture using litmus papers

(b) Remove another small piece of phosphorus from water and using a deflagrating spoon (with a lid cover) place it on a Bunsen flame.

Slowly lower it into a gas jar containing Oxygen gas with about 5 cm³ of water. Observe.

Swirl. Test the solution/mixture using litmus papers.

Observations

-Phosphorus catches fire before heating on Bunsen flame

-Dense white fumes of a gas produced that has pungent choking **poisonous** smell

-Solution formed turn **blue** litmus paper faint **red**.

Red litmus paper remains **red**.

Explanation

Phosphorus is stored in water. On exposure to air it instantaneously fumes then catch fire to burn in air and faster in Oxygen with a **yellow** flame producing dense white acidic fumes of Phosphorus(V) oxide gas.

Phosphoric(V) oxide gas dissolve in water to form weak acidic solution of Phosphoric (V)acid.

Chemical Equation

Phosphorus + Oxygen -> Phosphorous(V)oxide



Phosphorous(V)oxide + Water -> Phosphoric(V)acid



(e) Reactivity series/competition for combined Oxygen.

The reactivity series is a list of elements/metals according to their affinity for oxygen. Some metals have higher affinity for Oxygen than others.

A metal/element with higher affinity for oxygen is placed higher/on top of the one less affinity.



The complete reactivity series of metals/elements

Element/Metal	Symbol
Potassium	K
Sodium	Na
Calcium	Ca
Magnesium	Mg
Aluminium	Al
Carbon	C
Zinc	Zn
Iron	Fe
Tin	Sn
Lead	Pb
Hydrogen	H
Copper	Cu
Mercury	Hg
Silver	Ag
Gold	Au
Platinum	Pt

Most reactive



Least reactive

Metals compete for combined Oxygen. A metal/element with higher affinity for oxygen removes Oxygen from a metal lower in the reactivity series/less affinity for Oxygen.

When a metal/element gains/acquire Oxygen, the **process** is called **Oxidation**.

When a metal/element donate/lose Oxygen, the **process** is called **Reduction**.

An element/metal/compound that undergo Oxidation is called **Reducing agent**.

An element/metal/compound that undergo Reduction is called **Oxidizing agent**.

A reaction in which **both** Oxidation and Reduction take place is called a **Redox** reaction.

Redox reaction between Magnesium and copper(II)Oxide

Procedure

Place about 2g of copper (II)oxide in a crucible with a lid. Place another 2g of Magnesium powder into the crucible. Mix thoroughly.

Cover the crucible with lid. Heat strongly for five minutes.

Allow the mixture to cool. Open the lid. Observe.

Observation

Colour change from black to brown. White solid power formed.

Explanation

Magnesium is higher in the reactivity series than Copper. It has therefore higher affinity for Oxygen than copper.

When a mixture of copper(II)oxide and Magnesium is heated, Magnesium reduces copper(II)oxide to brown copper metal and itself oxidized to Magnesium oxide.

Magnesium is the reducing agent because it undergoes oxidation process.

Copper(II)oxide is the oxidizing agent because it undergo **redox** reduction process.

The mixture should be cooled before opening the lid to prevent **hot** brown copper from being **reoxidized** back to black copper(II)oxide.

The reaction of Magnesium and Copper(II)oxide is a reaction

Chemical equation

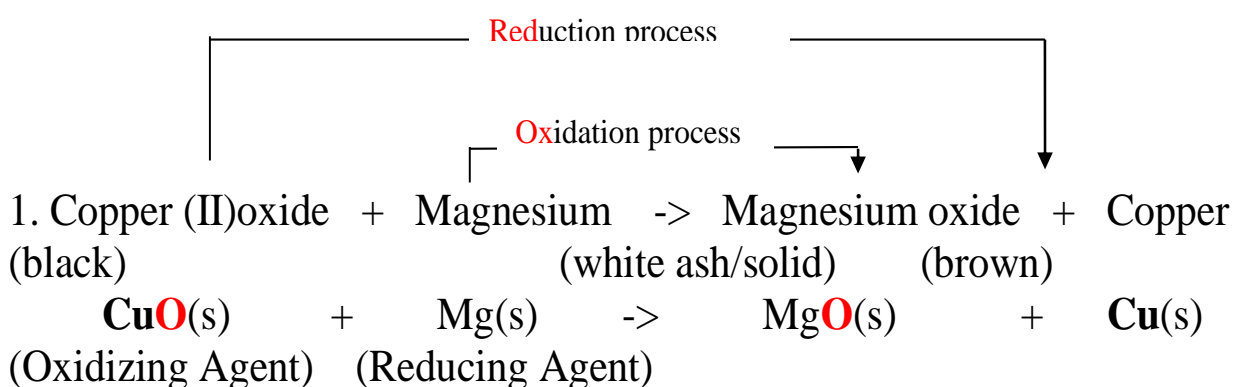

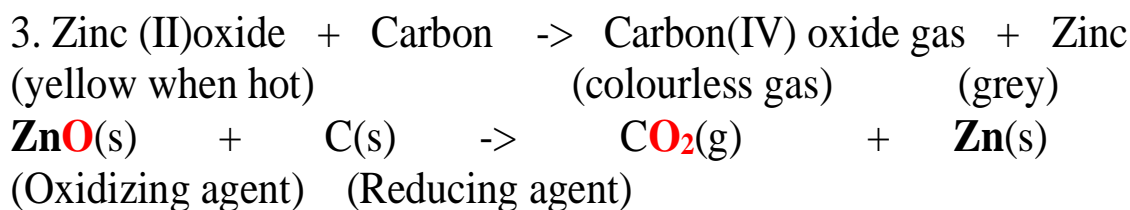
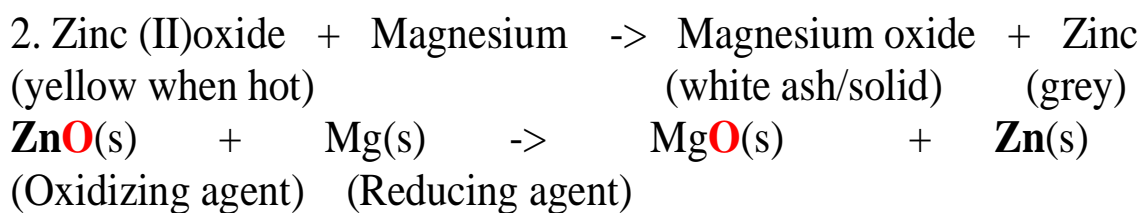

The reactivity series is used during extraction of metals from their ore. An ore is a rock containing mineral element which can be extracted for commercial purposes. Most metallic ores occur naturally as:

- (i) **oxides** combined with Oxygen
- (ii) **sulphides** combined with Sulphur
- (iii) **carbonates** combined with carbon and Oxygen.

Metallic ores that naturally occur as metallic sulphides are first **roasted** in air to form the corresponding oxide. Sulphur(IV)oxide gas is produced. e.g.

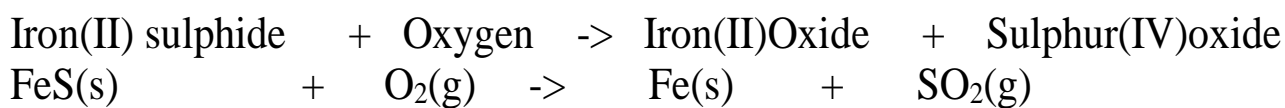
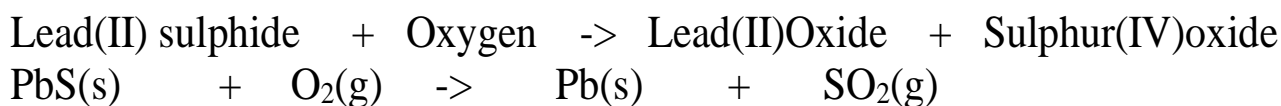
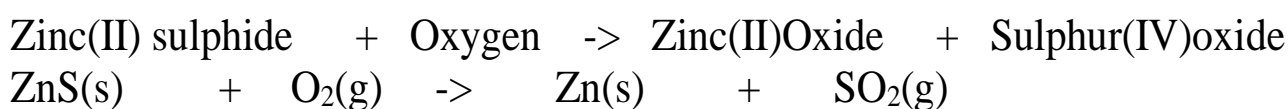
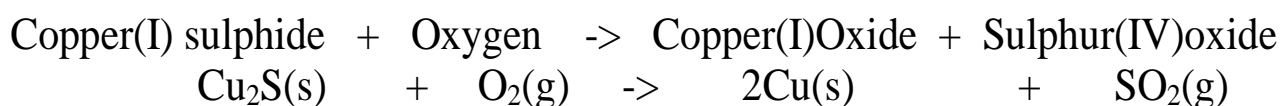

Metallic ores that naturally occur as metallic carbonates are first **heated** in air. They **decompose**/split to form the corresponding oxide and produce Carbon (IV) oxide gas.

e.g.

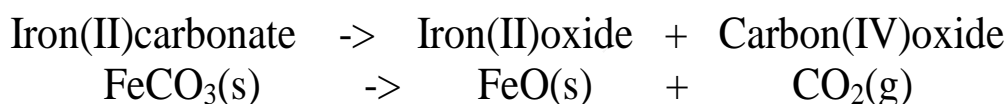
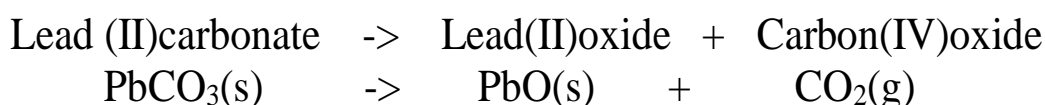
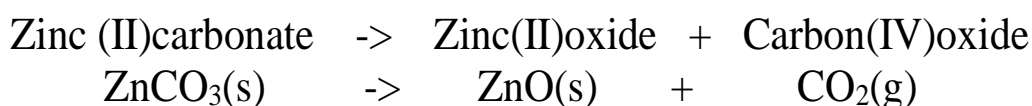
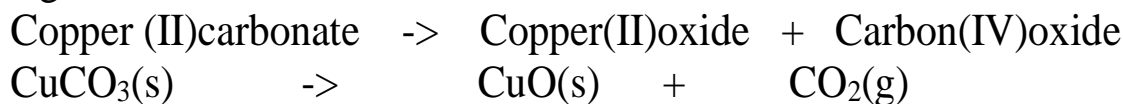

Metallic ores

Water and Hydrogen

A. WATER

Pure water is a **colourless, odourless, tasteless, neutral liquid**. Pure water does not exist in nature but naturally in varying degree of purity. The main sources of water include rain, springs, borehole, lakes, seas and oceans:

Water is generally **used** for the following purposes:

- (i) drinking by animals and plants.
- (ii) washing clothes.
- (iii) bleaching and dyeing.
- (iv) generating hydroelectric power.



(v)cooling industrial processes.

Water dissolves many substances/solutes.

It is therefore called **universal solvent**.

It contains about 35% **dissolved** Oxygen which support aquatic fauna and flora.

Water naturally exist in three phases/states **solid** ice,**liquid** water and **gaseous** water vapour.

The three states of water are naturally **interconvertible**.

The natural interconversion of the three phases/states of water forms the water cycle.

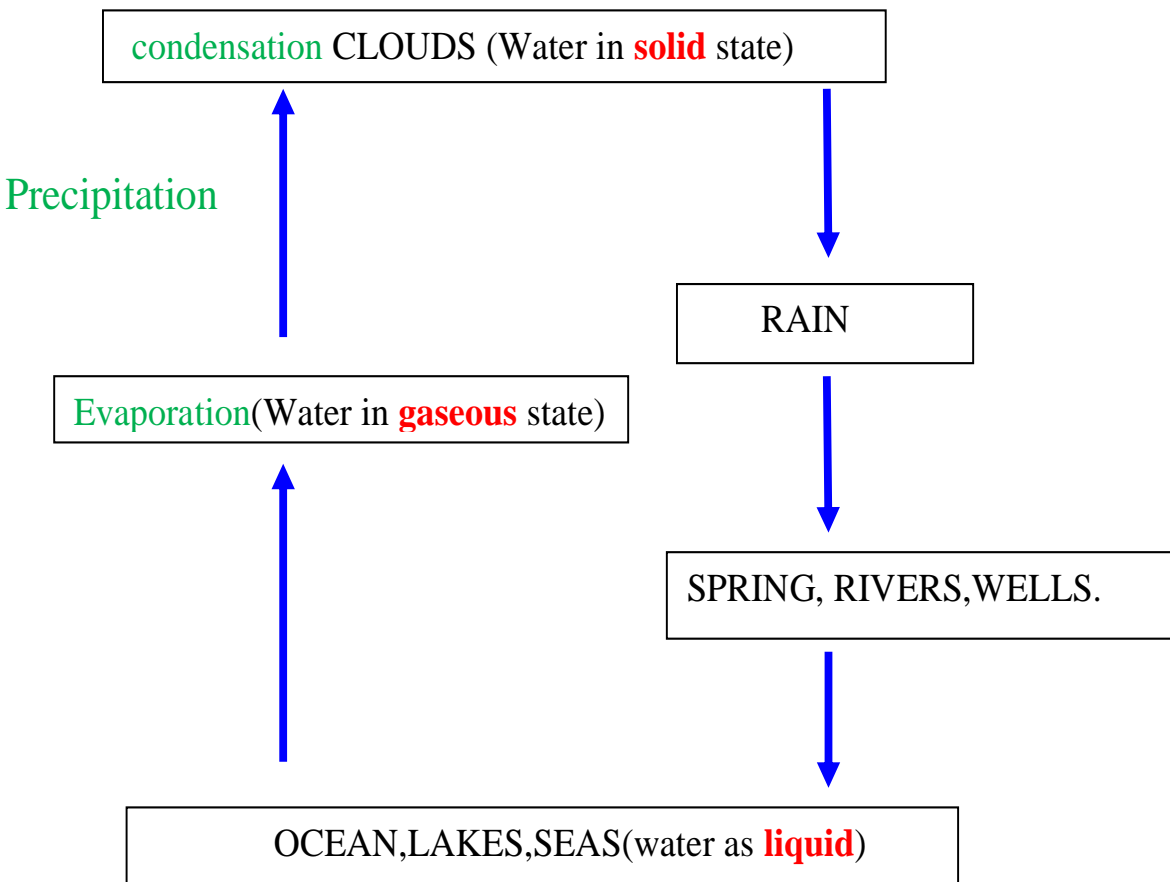

Liquid water in land, lakes, seas and oceans use the solar/sun **energy** to **evaporate/vapourize** to form water vapour/**gas**. Solar/sun energy is also used during transpiration by plants and respiration by animals.

During evaporation, the water vapour rises up the earth's surface. Temperatures decrease with height above the earth's surface increase. Water vapour therefore cools as it rises up. At a height where it is cold enough to below 373Kelvin/100°C Water vapour loses enough energy to form tiny droplets of liquid.

The process by which a gas/water vapour changes to a liquid is called **condensation/liquidification**.

On further cooling, the liquid loses more energy to form **ice/solid**. The process by which a liquid/water changes to a ice/solid is called **freezing/solidification**. Minute/tiny ice/solid particles float in the atmosphere and coalesce/join together to form clouds. When the clouds become too heavy they fall to the earth's surface as rain/snow as the temperature increases with the fall.

Interconversion of the three phases/states water

Evaporation /boiling/vapourization	Liquidification/ condensation
Melting liquidification	Freezing Solidification

Pure water has :

- (i) fixed/constant/sharp freezing point/melting point of **273K/0°C**
- (ii) fixed/constant/sharp boiling point of **373K/100°C** at sea level/1 atmosphere pressure
- (iii) fixed density of **1gcm⁻³**

This is the **criteria** of identifying pure/purity of water.

Whether a substance is water can be determined by using the following methods:



a) To test for presence of water using anhydrous copper(II)sulphate(VI)

Procedure.

Put about 2g of anhydrous copper(II)sulphate(VI) crystals into a clean test tube. Add three drops of tap water. Repeat the procedure using distilled water.

Observation.

Colour changes from white to blue

Explanation.

Anhydrous copper(II)sulphate(VI) is white. On adding water, anhydrous copper(II)sulphate(VI) gains/reacts with water to form hydrated copper(II) sulphate(VI).

Hydrated copper(II) sulphate(VI) is blue. Hydrated copper(II) sulphate(VI) contain water of crystallization.

The change of white anhydrous copper(II)sulphate(VI) to blue hydrated copper(II) sulphate(VI) is a confirmatory test for the presence of water

Chemical equation.

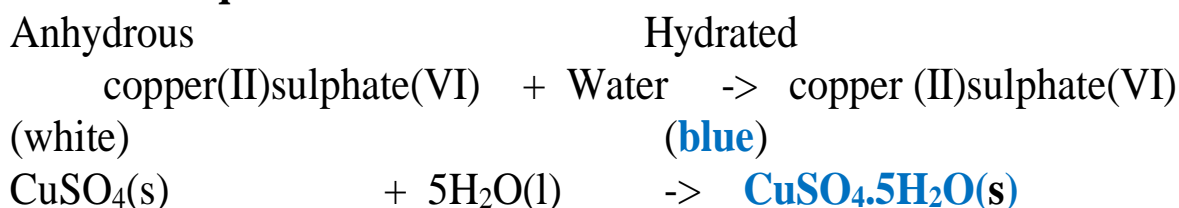

b) To test for presence of water using anhydrous cobalt(II)chloride

Procedure.

Put about 5cm³ of water into a clean test tube.

Dip a dry anhydrous cobalt(II)chloride paper into the test tube.

Repeat the procedure using distilled water.

Observation.

Colour changes from blue to pink

Explanation.

Anhydrous cobalt(II)chloride is blue. On adding water, anhydrous cobalt(II)chloride gains/reacts with water to form hydrated cobalt(II) chloride.



Hydrated cobalt(II)chloride is **pink**.

Hydrated cobalt (II)chloride contain water of crystallization.

The change of blue **anhydrous** cobalt(II)chloride to **pink** hydrated cobalt(II)chloride is a confirmatory test for the **presence** of water **Chemical equation.**

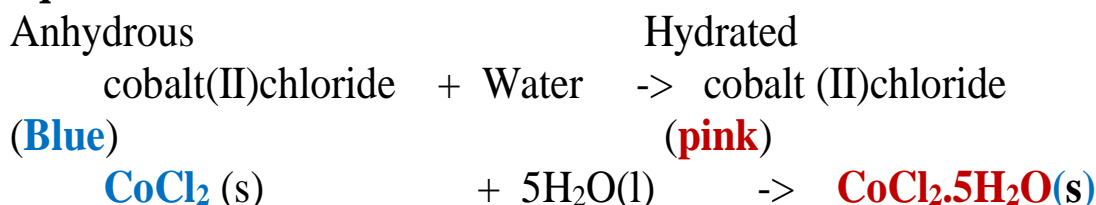

Burning a candle in air

Most organic substances/fuels burn in air to produce water. Carbon(IV)oxide gas is also produced if the air is sufficient/excess.

Procedure

Put about 2g of anhydrous copper(II)sulphate(VI)crystals in a boiling tube.

Put about 5cm³ of lime water in a boiling tube.

Light a small candle stick. Place it below an inverted thistle/filter funnel

Collect the products of the burning candle by setting the apparatus as below

Set up of apparatus



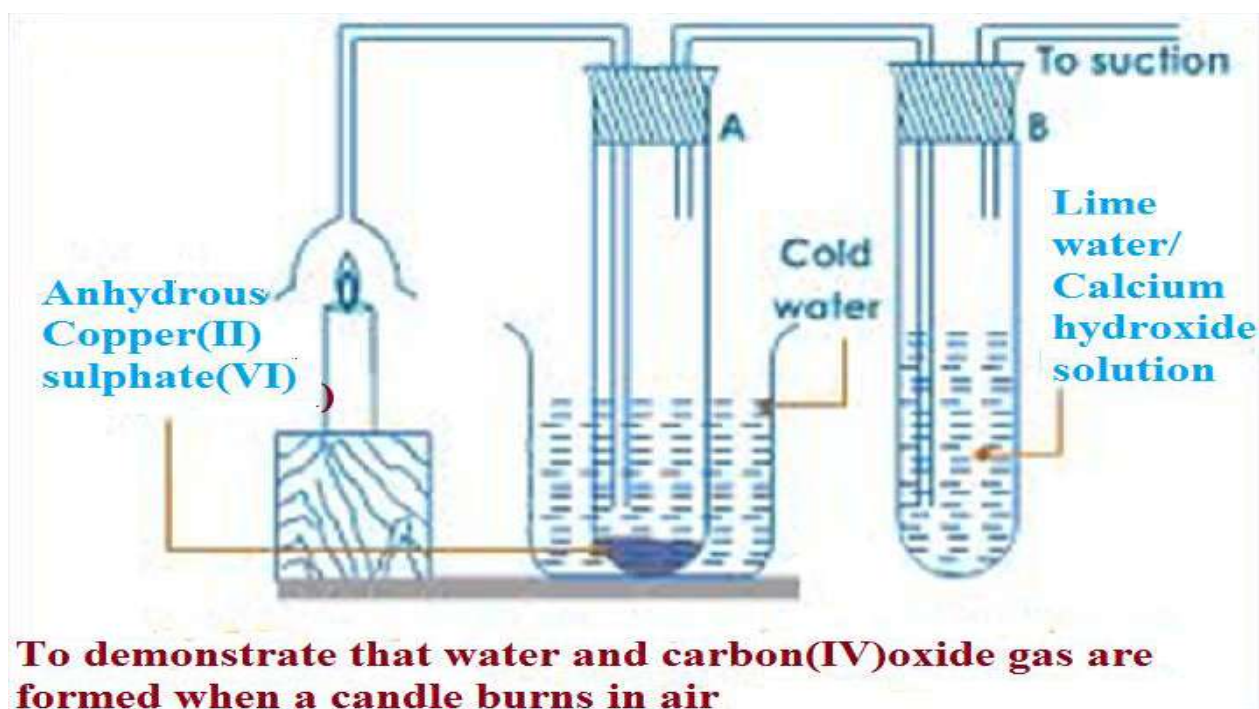

Observation

The suction pump pulls the products of burning into the inverted funnel. Colour of anhydrous copper(II) sulphate(VI) changes from white to **blue**. A **white precipitate** is formed in the lime water/calcium hydroxide.

Explanation

When a candle burn it forms a water and carbon(IV)oxide.

Water turns anhydrous copper(II) sulphate(VI) changes from white to **blue**.

Carbon(IV)oxide gas forms **white precipitate** when bubbled in lime water/calcium hydroxide.

Since:

(i) hydrogen in the wax burn to form water

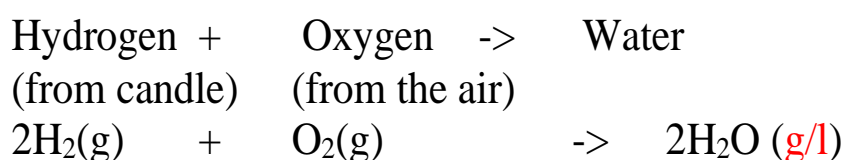

(ii) carbon in the wax burn to form carbon(IV)oxide



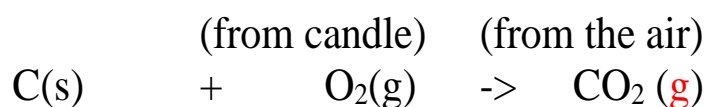

The candle before burning therefore contained only **Carbon** and **Hydrogen only**. A compound made up of **hydrogen** and carbon is called **Hydrocarbon**.

A candle is a hydrocarbon.

Other hydrocarbons include: Petrol, diesel, Kerosene, and Laboratory gas. Hydrocarbons burn in air to form water and carbon(IV)oxide gas.



Water pollution

Water pollution take place when undesirable substances are added into the water.

Sources of water pollution include:

- (i)Industrial chemicals being disposed into water bodies like rivers, lakes and oceans.
- (ii)Discharging untreated /raw sewage into water bodies.
- (iii)Leaching of insecticides/herbicides form agricultural activities into water bodies.
- (iv)Discharging non-biodegradable detergents after domestic and industrial use into water bodies.
- (v)Petroleum oil spilling by ships and oil refineries
- (vi)Toxic/poisonous gases from industries dissolving in rain .
- (vii) Acidic gases from industries dissolving in rain to form “acid rain”
- (viii)Discharging hot water into water bodies.This reduces the quantity of dissolved Oxygen in the water killing the aquatic fauna and flora.

Water pollution can be reduced by:

- (i)reducing the use of agricultural fertilizers and chemicals in agricultural activities.
- (ii)use of biological control method instead of insecticides and herbicides
- (iii)using biodegradable detergents

Reaction of metals with water



Some metals react with water while others do not. The reaction of metals with water depend on the reativity series. The higher the metal in the reactivity series the more reactive the metal with water .The following experiments shows the reaction of metals with cold water and water vapour/steam.

(a)Reaction of sodium/ potassium with cold water:

Procedure

Put about 500cm³ of water in a beaker. Add three drops of phenolphthalein indicator/litmus solution/universal indicator solution/methyl orange indicator into the water.

Cut a **very small** piece of sodium .Using a pair of forceps, put the metal into the water.

Observation

Sodium melts to a silvery ball that floats and darts on the surface decreasing in size.Effervescence/fizzing/ bubbles of colourless gas produced.

Colour of phenolphthalein turns **pink**

Colour of litmus solution turns **blue**

Colour of methy orange solution turns **Orange**

Colour of universal indicator solution turns **blue**

Explanation

Sodium is less dense than water. Sodium floats on water and vigorously react to form an **alkaline** solution of sodium hydroxide and producing hydrogen gas. Sodium is thus stored in paraffin to prevent **contact** with water.

Chemical equation

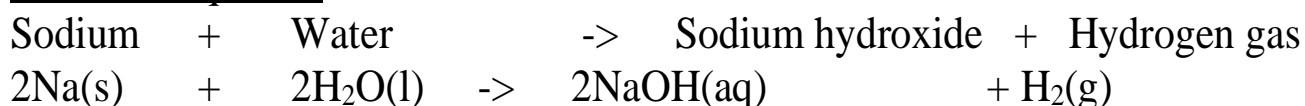

To collect hydrogen gas , Sodium metal is forced to **sink** to the bottom of the trough/beaker by wrapping it in wire gauze/mesh.



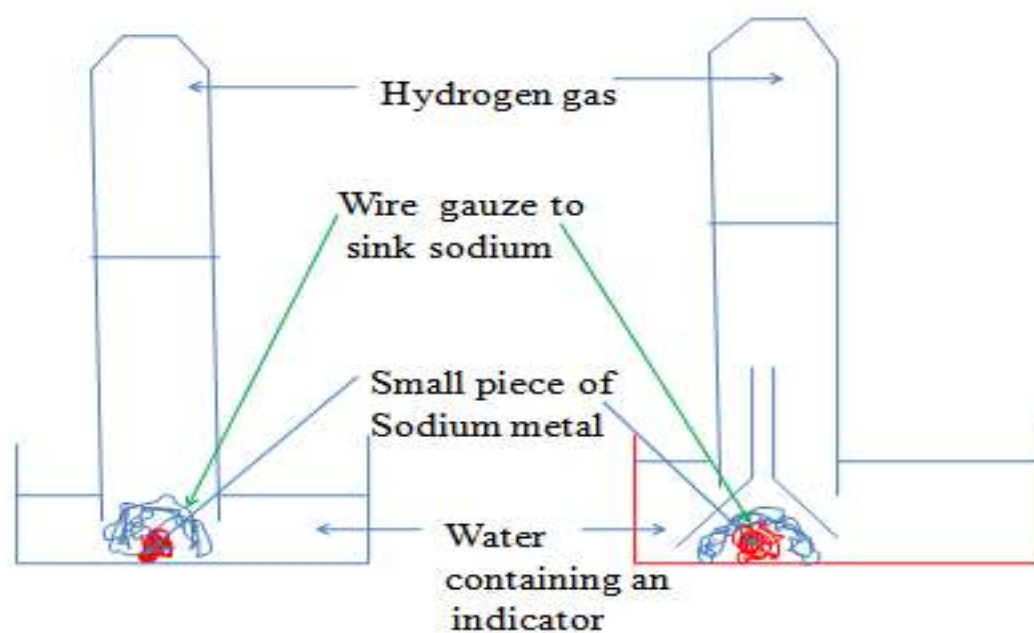

Potassium is more reactive than Sodium. On contact with water it **explodes**/burst into flames. An alkaline solution of potassium hydroxide is formed and hydrogen gas

Chemical equation

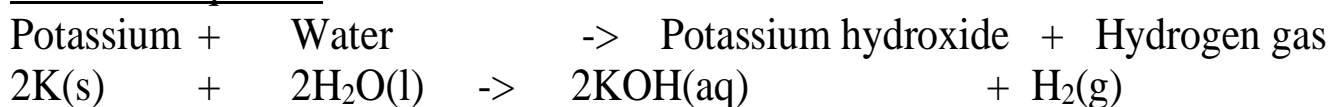

Caution: Reaction of Potassium with water is very risky to try in a school laboratory.

(b)Reaction of Lithium/ Calcium with cold water:

Procedure

Put about 200cm³ of water in a beaker. Add three drops of phenolphthalein indicator/litmus solution/universal indicator solution/methyl orange indicator into the water.

Cut a small piece of Lithium .Using a pair of forceps, put the metal into the water. Repeat with a piece Calcium metal

Observation

Lithium sinksto the bottom of the water.Rapid effervescence/fizzing/ bubbles of colourless gas produced.

Colour of phenolphthalein turns **pink**

Colour of litmus solution turns **blue**

Colour of methy orange solution turns **Orange**

Colour of universal indicator solution turns **blue**

Explanation

Lithium and calcium are **denser** than water. Both sink in water and vigorously react to form an **alkaline** solution of Lithium hydroxide / calcium hydroxide and producing hydrogen gas. Lithium is more reactive than calcium. It is also stored in paraffin like Sodium to prevent **contact** with water.

Chemical equation

Lithium + Water \rightarrow Lithium hydroxide + Hydrogen gas

$2\text{Li(s)} + 2\text{H}_2\text{O(l)} \rightarrow 2\text{LiOH(aq)} + \text{H}_2\text{(g)}$

Calcium + Water \rightarrow Calcium hydroxide + Hydrogen gas

$\text{Ca(s)} + 2\text{H}_2\text{O(l)} \rightarrow \text{Ca(OH)}_2\text{(aq)} + \text{H}_2\text{(g)}$

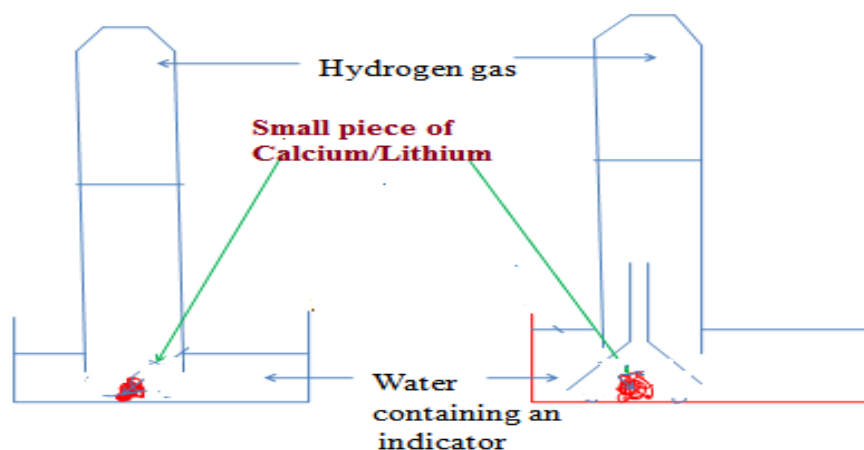

Collection of hydrogen from reaction of Lithium /calcium with water

(c) Reaction of Magnesium/Zinc/ Iron with Steam/water vapour:

Procedure method1

Place some wet sand or cotton/glass wool soaked in water at the bottom of an ignition/hard glass boiling tube.

Polish magnesium ribbon using sand paper.

Coil it at the centre of the ignition/hard glass boiling tube.

Set up the apparatus as below.

Heat the wet sand or cotton/glass wool soaked in water gently to:

(i)drive away air in the ignition/hard glass boiling tube.

(ii)generate steam

Heat the coiled ribbon strongly using another burner.Repeat the experiment using Zinc powder and fresh Iron filings.

Set up of apparatus

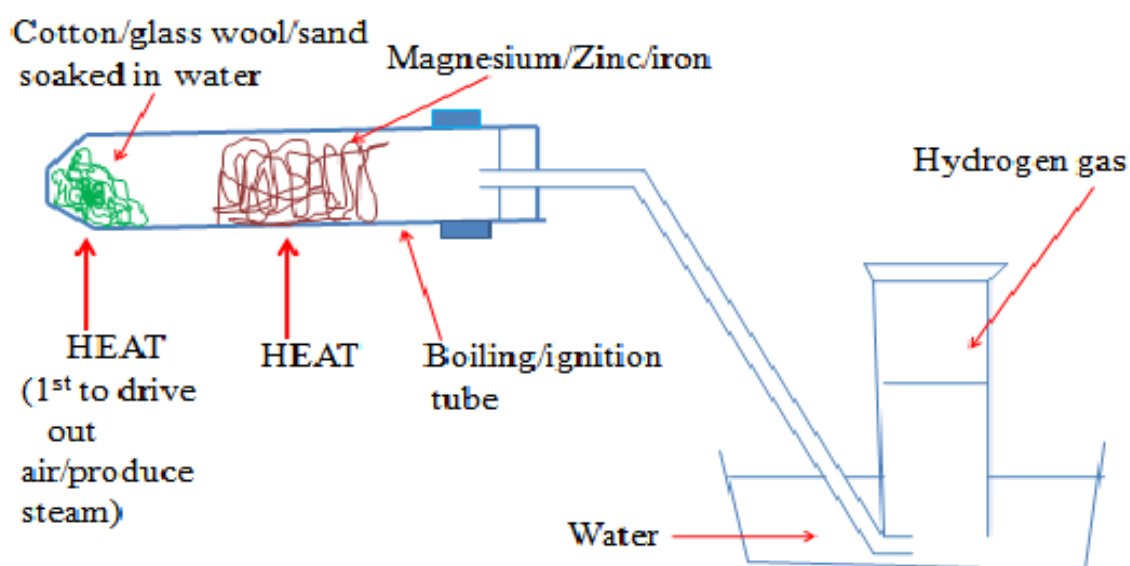

Reaction of Steam/water vapour with Magnesium /Zinc/iron

Observations

(i)With Magnesium ribbon:

The Magnesium glow with a bright flame (and continues to burn even if heating is stopped)

White solid /ash formed

White solid /ash formed dissolve in water to form a colourless solution

Colourless gas produced/collected that extinguish burning splint with “pop sound”

(ii)With Zinc powder:

The Zinc powder turns red hot on strong heating

Yellow solid formed that turn white on cooling

White solid formed on cooling does not dissolve in water.

(iii)With Iron fillings:

The Iron fillings turns red hot on strong heating

Dark blue solid formed

Dark blue solid formed does not dissolve in water.

Procedure method 2

Put some water in a round bottomed flask

Polish magnesium ribbon using sand paper.

Coil it at the centre of a hard glass tube

Set up the apparatus as below.

Heat water strongly to boil so as to:

(i)drive away air in the glass tube.

(ii)generate steam

Heat the coiled ribbon strongly using another burner. Repeat the experiment using Zinc powder and fresh Iron filings.



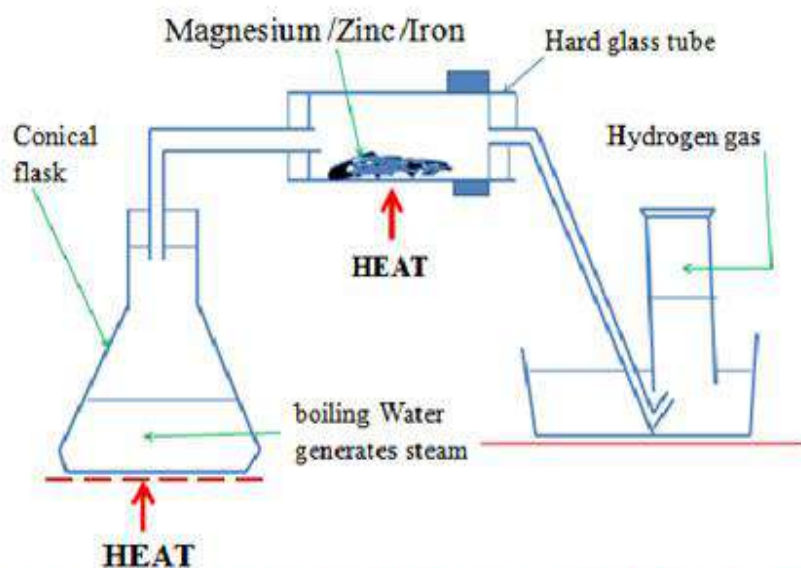

Method 2: Reaction of steam with Magnesium / Zinc / Iron

Observations

(i) With Magnesium ribbon:

The Magnesium glow with a bright flame (and continues to burn even if heating is stopped)

White solid /ash formed

White solid /ash formed dissolve in water to form a colourless solution

Colourless gas produced/collected that extinguish burning splint with “pop sound”

(ii) With Zinc powder:

The Zinc powder turns red hot on strong heating

Yellow solid formed that turn white on cooling

White solid formed on cooling does not dissolve in water.

(iii) With Iron fillings:

The Iron fillings turns red hot on strong heating

Dark blue solid formed

Dark blue solid formed does not dissolve in water.

Explanations

(a) Hot magnesium burns vigorously in steam. The reaction is highly exothermic, generating enough heat/energy to proceed without further heating.

White magnesium oxide solid/ash is left as residue.

Hydrogen gas is produced. It extinguishes a burning splint with a "pop sound".

Chemical Equation

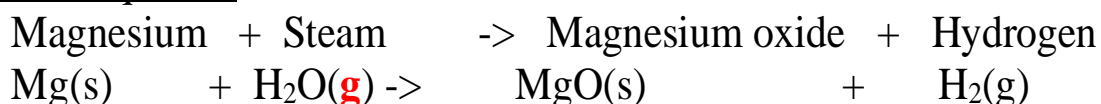

Magnesium oxide reacts/dissolves in water to form an alkaline solution of magnesium oxide.

Chemical Equation

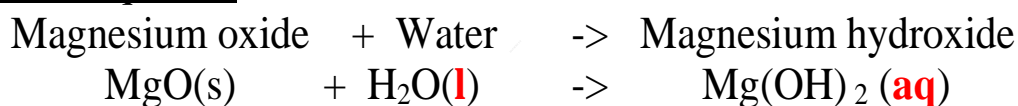

(b) Hot zinc reacts vigorously in steam, forming yellow zinc oxide solid/ash as residue, which cools to white.

Hydrogen gas is produced. It extinguishes a burning splint with a "pop sound".

Chemical Equation

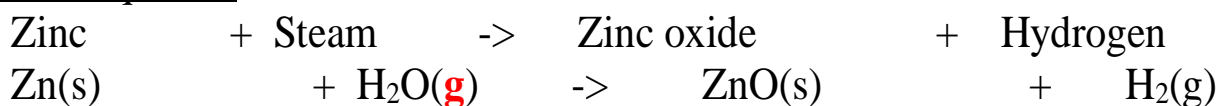

Zinc oxide does not dissolve in water.

(c) Hot iron reacts with steam, forming dark blue triiron tetroxide solid/ash as residue. Hydrogen gas is produced. It extinguishes a burning splint with a "pop sound".

Chemical Equation



Tri iron tetra oxide does not dissolve in water.



(d) Aluminium reacts with steam forming an **insoluble coat**/cover of **impervious** layer of aluminium oxide on the surface preventing further reaction.

(e) Lead, Copper, Mercury, Silver, Gold and Platinum **do not** react with either water or steam.

HYDROGEN

Occurrence

Hydrogen does not occur free in nature. It occurs as Water and in Petroleum.

School laboratory Preparation

Procedure

Put Zinc granules in a round/flat/conical flask. Add dilute sulphuric(VI) /Hydrochloric acid.

Add about 3cm³ of copper(II)sulphate(VI) solution.

Collect the gas produced over water as in the set up below.

Discard the first gas jar. Collect several gas jar.

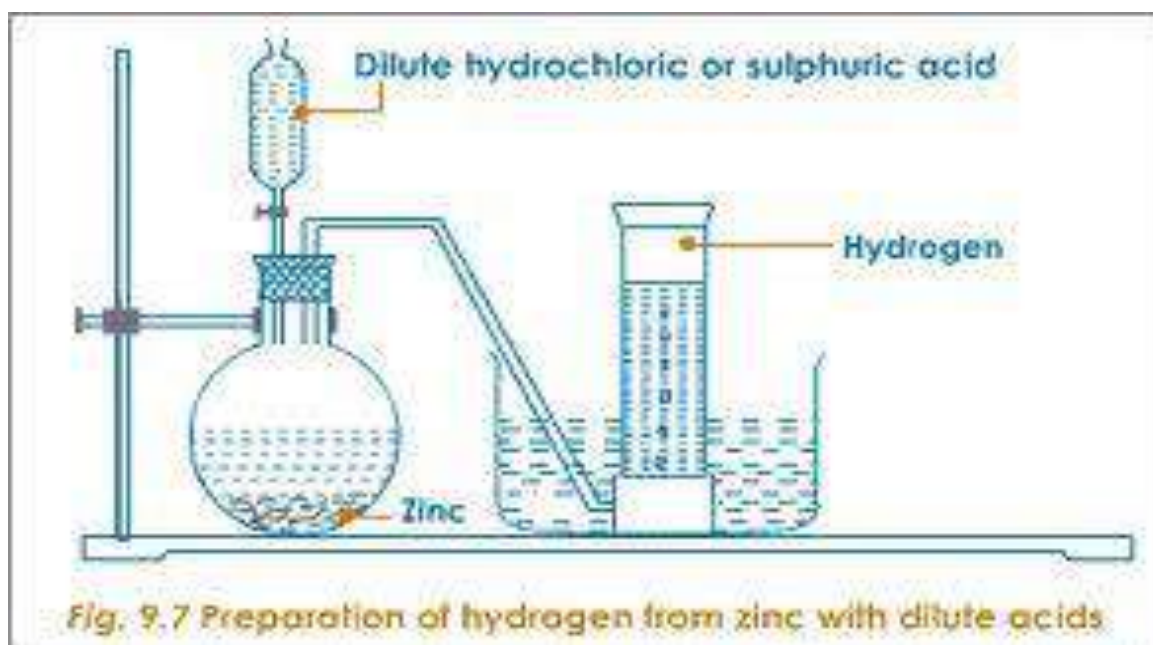

Observation/Explanation

Zinc reacts with dilute sulphuric(VI)/hydrochloric acid to form a salt and produce hydrogen gas.

When the acid comes into contact with the metal, there is rapid effervescence/ bubbles /fizzing are produced and a colourless gas is produced that is collected:

(i) over water because it is insoluble in water

(ii) through downward displacement of air/upward delivery because it is less dense than air.

The first gas jar is impure. It contains air that was present in the apparatus.

Copper(II)sulphate(VI)solution act as catalyst.

Chemical equation

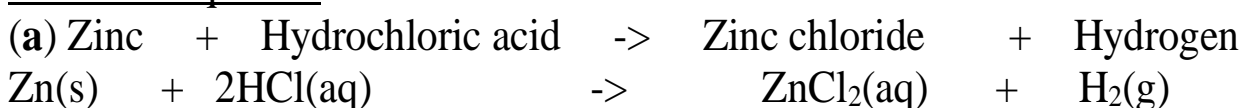

Ionic equation

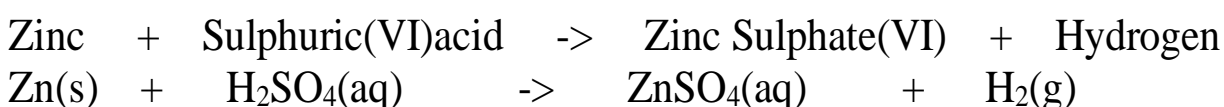

Ionic equation

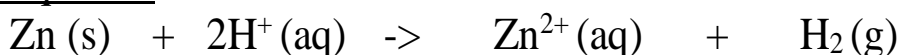

(b) Chemical equation

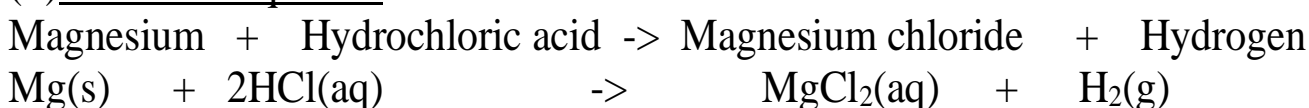

Ionic equation

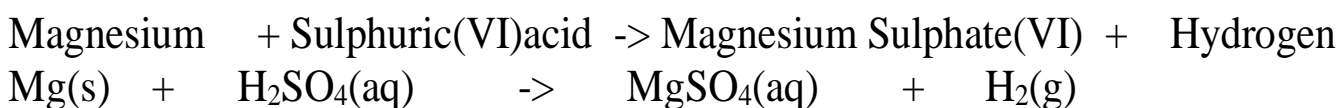

Ionic equation



(c) Chemical equation

Iron + Hydrochloric acid \rightarrow Iron(II)chloride + Hydrogen

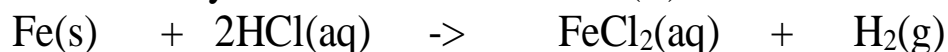

Ionic equation



Iron + Sulphuric(VI)acid \rightarrow Iron(II) Sulphate(VI) + Hydrogen



Ionic equation



Note

1. Hydrogen cannot be prepared from reaction of:

(i) Nitric(V)acid and a metal. Nitric(V)acid is a strong oxidizing agent. It **oxidizes** hydrogen gas to **water**.

(ii) dilute sulphuric(VI)acid with calcium/Barium/Lead because Calcium sulphate(VI), Barium sulphate(VI) and Lead(II)sulphate(VI) salts formed are insoluble. Once formed, they **cover/coat** the **unreacted** calcium/Barium/Lead **stopping** further reaction and producing very small amount/volume of hydrogen gas.

(iii) dilute acid with sodium/potassium. The reaction is **explosive**.

Properties of Hydrogen gas

(a) Physical properties

1. Hydrogen is a **neutral ,colourless** and **odourless** gas. When mixed with air it has a characteristic pungent choking smell

2. It is insoluble in water thus can be collected over water.

3. It is the lightest known gas. It can be transferred by inverting one gas jar over another.

(b) Chemical properties.

(i) Burning



I. Hydrogen does not support burning/combustion. When a burning splint is inserted into a gas jar containing Hydrogen, the flame is extinguished /put off.

II. Pure dry hydrogen burn with a blue quiet flame to form water. When a stream of pure dry hydrogen is ignited, it catches fire and continues to burn with a blue flame.

III. Impure (air mixed with) hydrogen burns with an explosion. Small amount/volume of air **mixed** with hydrogen in a test tube produce a small explosion as a “pop” sound. This is the confirmatory test for the presence of Hydrogen gas. A gas that burns with a “pop” sound is confirmed to be Hydrogen.

(ii)Redox in terms of Hydrogen transfer

Redox can also be defined in terms of Hydrogen transfer.

(i)Oxidation is removal of Hydrogen

(ii)Reduction is addition of Hydrogen

(iii)Redox is simultaneous addition and removal of Hydrogen

Example

When a stream of dry hydrogen gas is passed through black copper (II) oxide, hydrogen gas gains the oxygen from copper(II)oxide.

Black copper (II) oxide is reduced to brown copper metal.

Black copper(II)oxide os thus the Oxidizing agent.

Hydrogen gas is oxidized to Water. Hydrogen is the Reducing agent.

Set up of apparatus



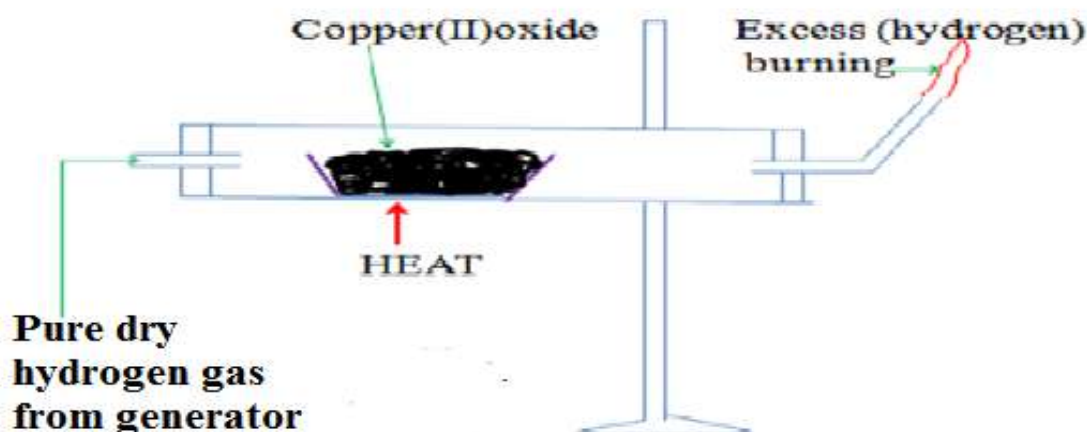

Reduction of Copper(II)Oxide by Hydrogen gas

(a) Chemical equation

(i) In glass tube

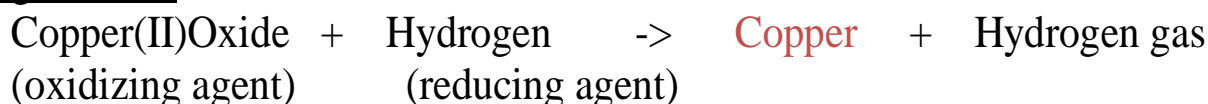

(ii) when excess Hydrogen is burning.

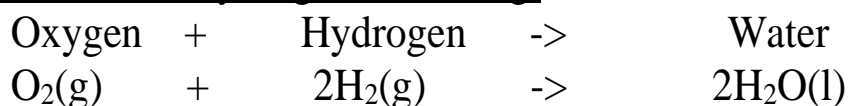

(b) Chemical equation

(i) In glass tube

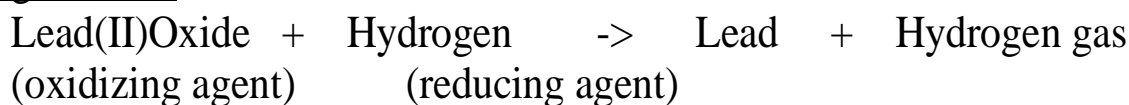

(brown when hot/
yellow when cool) (grey)

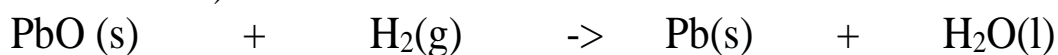

(ii) when excess Hydrogen is burning.





(c) Chemical equation

(i) In glass tube

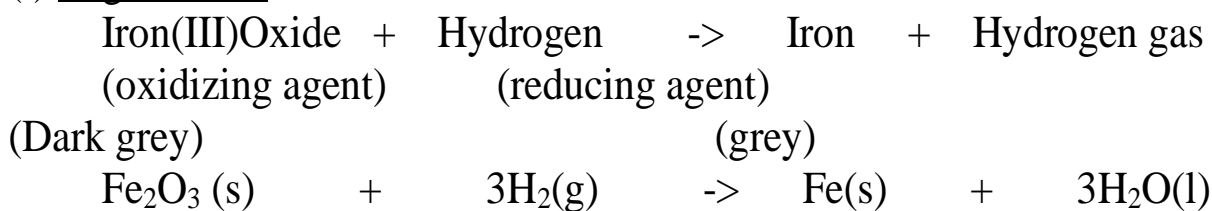

(ii) when excess Hydrogen is burning.

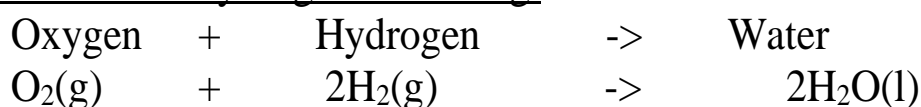

(iii) Water as an Oxide as Hydrogen

Burning is a reaction of an element with Oxygen. The substance formed when an element burn in air is the oxide of the element. When hydrogen burns, it reacts/combines with Oxygen to form the **oxide of Hydrogen**. The oxide of Hydrogen is called water. Hydrogen is first dried because a mixture of Hydrogen and air explode. The gas is then ignited. The products condense on a cold surface/flask containing a freezing mixture. A freezing mixture is a mixture of water and ice.



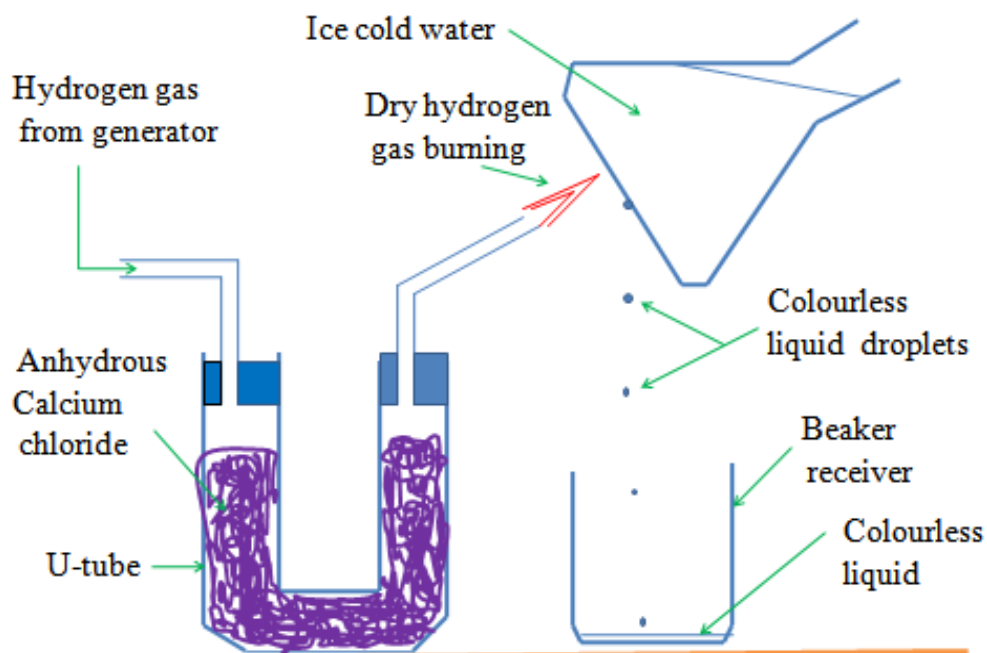

Burning Hydrogen: To show Water is an Oxide of Hydrogen

The condensed products are collected in a receiver as a colourless liquid.

Tests

(a) When about 1g of **white** anhydrous copper (II)sulphate(VI) is added to a sample of the liquid, it turns to **blue**. This confirms the liquid formed is water.

(b) When **blue** anhydrous cobalt (II)chloride paper is dipped in a sample of the liquid, it turns to **pink**. This confirms the liquid formed is water.

(c) When the liquid is heated to boil, its **boiling point** is **100°C** at sea level/one atmosphere pressure. This confirms the liquid is **pure water**.

Uses of Hydrogen gas

1. Hydrogenation/Hardening of unsaturated vegetable oils to saturated fats/margarine.

When Hydrogen is passed through unsaturated compounds in presence of **Nickel** catalyst and about **150°C**, they become saturated. Most vegetable oil are unsaturated liquids at room temperature. They become saturated and hard through hydrogenation.

2. In weather forecast balloons.

Hydrogen is the lightest known gas. Meteorological data is collected for analysis by sending hydrogen filled weather balloons to the atmosphere. The data collected is then used to forecast weather conditions.

3. In the Haber process for the manufacture of Ammonia

Hydrogen is mixed with Nitrogen in presence of Iron catalyst to form Ammonia gas. Ammonia gas is a very important raw material for manufacture of agricultural fertilizers.

4. In the manufacture of Hydrochloric acid.

Limited volume/amount of Hydrogen is burnt in excess chlorine gas to form Hydrogen chloride gas. Hydrogen chloride gas is dissolved in water to form Hydrochloric acid. Hydrochloric acid is used in pickling/washing metal surfaces.

5. As rocket fuel.

Fixed proportions of Hydrogen and Oxygen when ignited explode violently producing a lot of energy/heat. This energy is used to power/propel a rocket to space.

6. In oxy-hydrogen flame for welding.

A cylinder containing Hydrogen when ignited in pure Oxygen from a second cylinder produces a flame that is very hot. It is used to cut metals and welding.



Sample revision questions

1. A colourless liquid was added to anhydrous copper(II)sulphate(VI) which turned blue.

(a) Why is it wrong to conclude the liquid was pure water?

Anhydrous copper(II)sulphate(VI) test for presence of water. Purity of water is determined from freezing/melting/boiling point.

(b) Write an equation for the reaction that takes place with anhydrous copper(II)sulphate(VI)

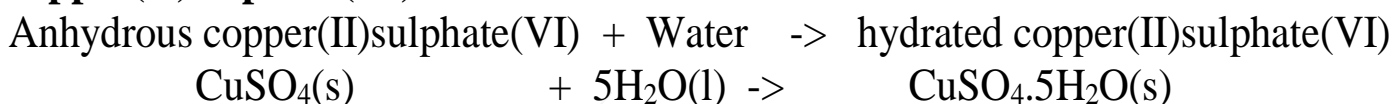

(c)(i) Which other compound would achieve the same results as anhydrous copper(II)sulphate(VI)

Anhydrous cobalt(II)chloride/CoCl₂·6H₂O

(ii) Write the equation for the reaction

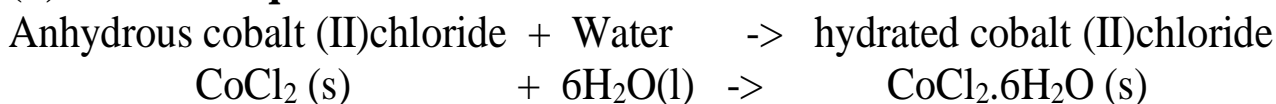

(d) Complete the equation

(i) Sulphur(VI)oxide + Water -> Sulphuric(VI)acid

(ii) Sulphur(IV)oxide + Water -> Sulphuric(IV)acid

(iii) Carbon(IV)oxide + Water -> Carbonic(IV)acid

(iv) Nitrogen(IV)oxide + Water -> Nitric(V)acid

(v) Phosphorus(V)oxide + Water -> Phosphoric(V)acid

(vi) Sodium oxide + Water -> Sodium hydroxide



(vi) Sodium peroxide + Water \rightarrow Sodium hydroxide

2. Metal B reacts with steam. Metal C reacts with cold water. Metal A does not react with water.

(a) Arrange the metals as they should appear in the reactivity series.

B

C

A

(b) A product residue in D which was brown when hot but turned yellow on cooling during the reaction of metal B was formed. Gas E was also evolved.

Identify

(i) Metal B Lead/Pb

(ii) Residue D Lead(II)oxide/PbO

(iii) Gas E Hydrogen/H₂

(c) A portion of product residue in D was added dilute nitric(V)acid. Another portion of product residue in D was added dilute sulphuric(VI)acid. State and explain the observations made.

When added dilute nitric(V)acid, D dissolves to form a colourless solution.

Lead(II)Oxide + dilute nitric(V)acid \rightarrow Lead(II) nitrate(V) + Water

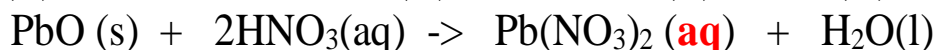

When added dilute sulphuric(VI)acid, D does not dissolve. A white suspension/precipitate was formed. Lead(II)Oxide reacts with sulphuric(VI)acid to form insoluble Lead(II)sulphate(VI) that cover/coat unreacted Lead(II)Oxide, stopping further reaction.

Lead(II)Oxide + dilute sulphuric(VI)acid \rightarrow Lead(II) sulphate(VI) + Water

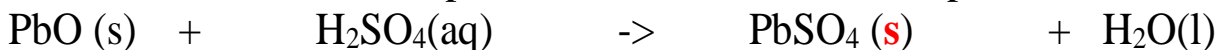

3. (a) Hydrogen can reduce copper(II)Oxide but not aluminium oxide. Explain
- (b) When water reacts with potassium metal the hydrogen produced ignites explosively on the surface of water.
- (i) What causes this ignition?
- (ii) Write an equation to show how this ignition occurs
2. In an experiment, dry hydrogen gas was passed over hot copper (II) oxide in a combustion tube as shown in the diagram below:

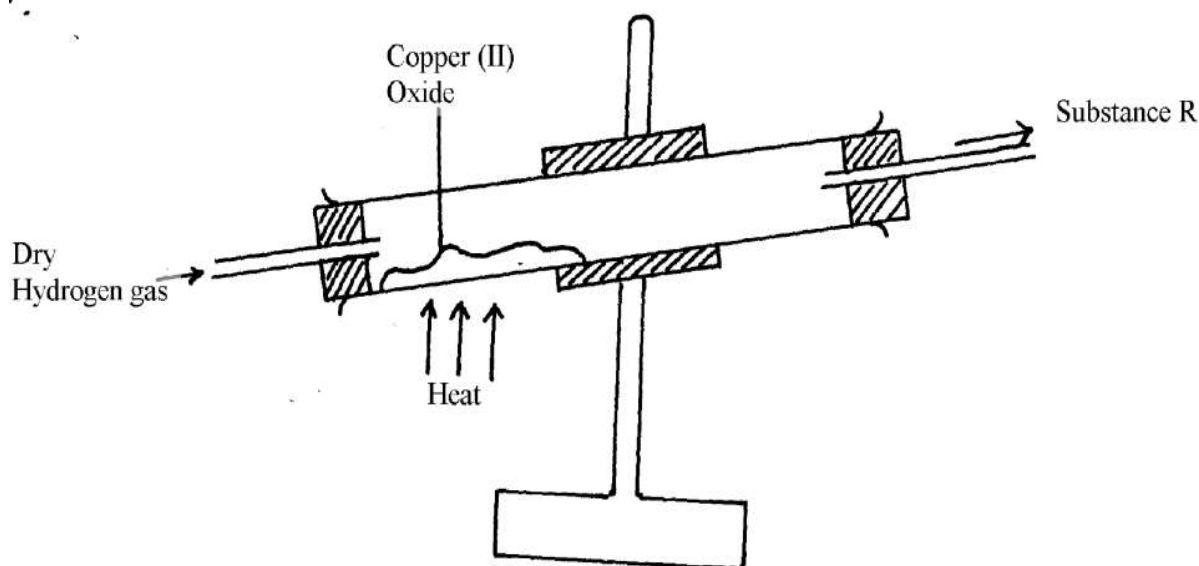

- (a) Complete the diagram to show how the other product, substance **R** could be collected in the laboratory.
- (b) Describe how copper could be obtained from the mixture containing copper (II) oxide

3. The setup below was used to investigate the reaction between metals and water.

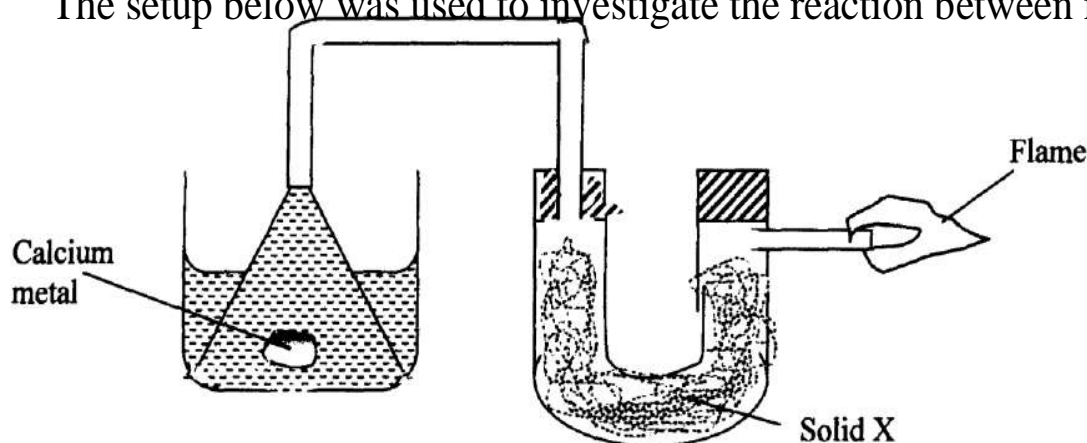

(a) Identify solid **X** and state its purpose

Solid X

Purpose

(b) Write a chemical equation for the reaction that produces the flame.

4. Gas **P** was passed over heated magnesium ribbon and hydrogen gas was collected as shown in the diagram below:

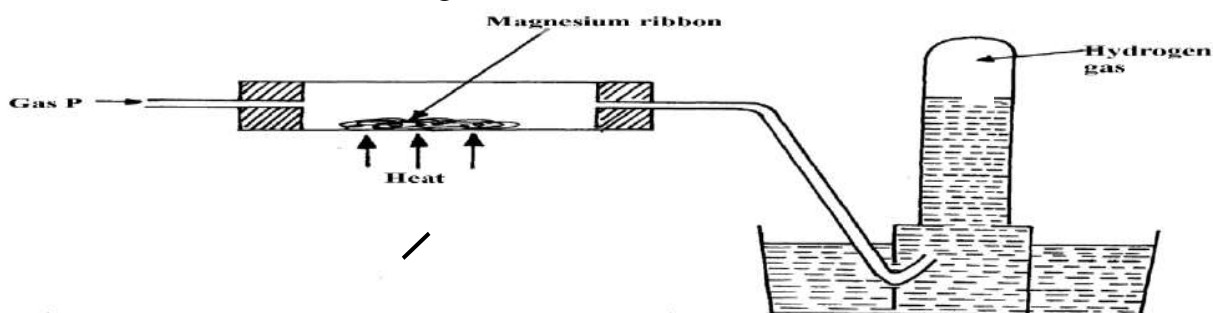

(i) Name gas **P**

(ii) Write an equation of the reaction that takes place in the combustion tube

(iii) State **one** precaution necessary at the end of this experiment

5. When hydrogen is burnt and the product cooled, the following results are obtained as shown in the diagram below:

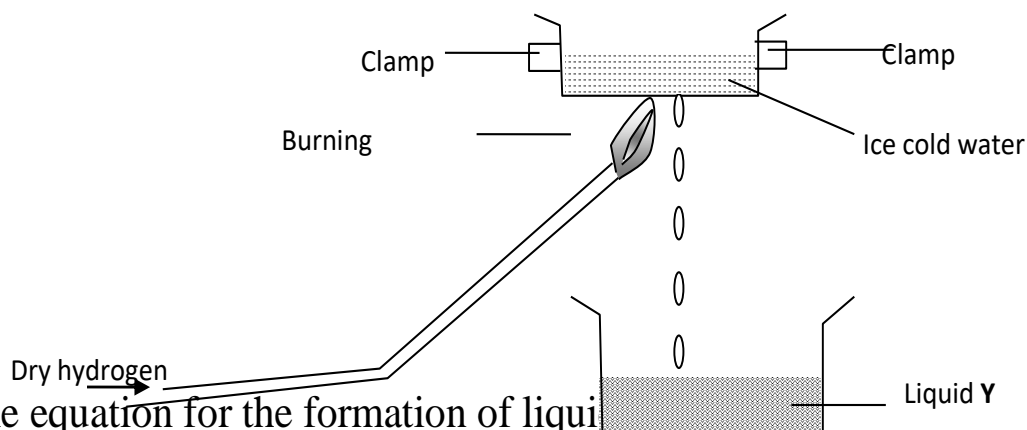

(a) Write the equation for the formation of liquid Y

(b) Give a chemical test for liquid Y

6. Jane set-up the experiment as shown below to collect a gas. The wet sand

was heated before

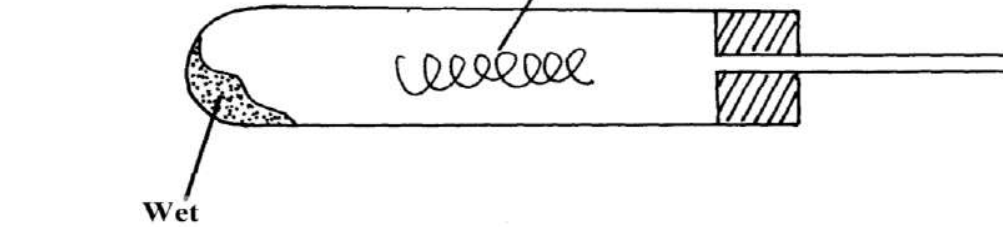

Wet sand

- (a) Complete the diagram for the laboratory preparation of the gas
- (b) Why was it necessary to heat wet sand before heating Zinc granules?

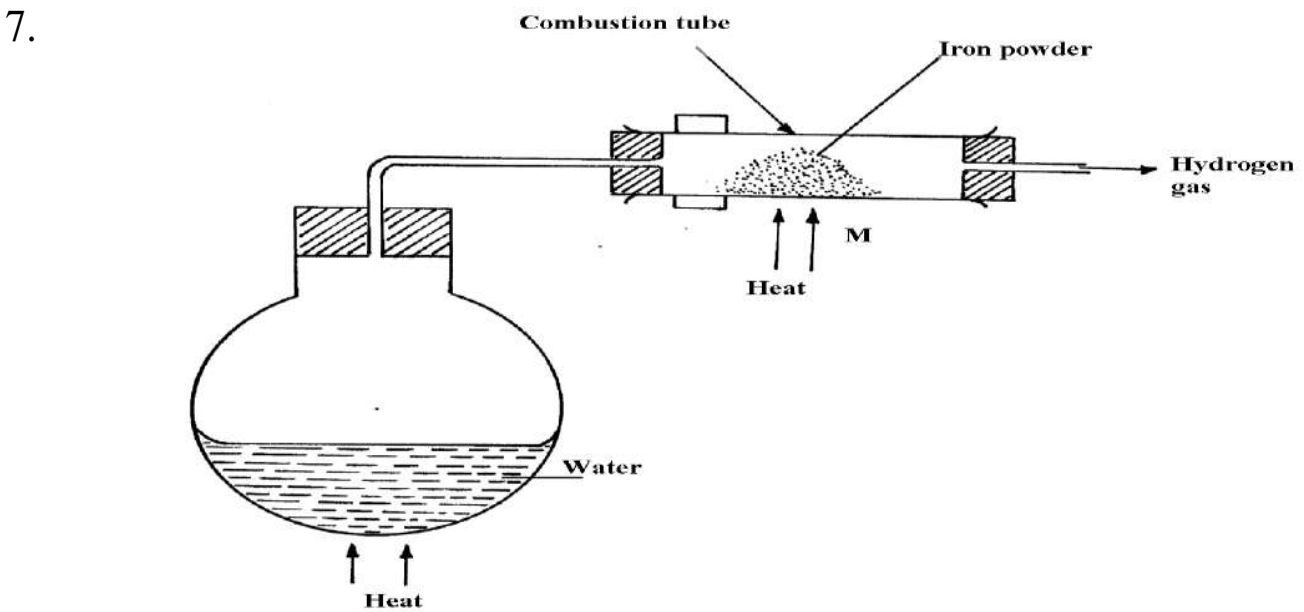

N

(a) Between N and M which part should be heated first? Explain

(b) Write a chemical equation for the reaction occurring in the combustion tube.

8. The set-up below was used to investigate electrolysis of a certain molten compound;-

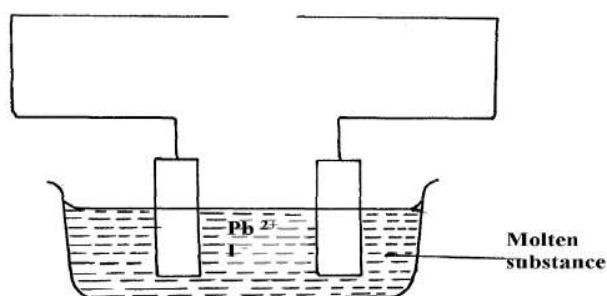

- (a) Complete the circuit by drawing the cell in the gap left in the diagram
- (b) Write half-cell equation to show what happens at the cathode
- (c) Using an arrow show the direction of electron flow in the diagram above

9. Hydrogen can be prepared by reacting zinc with dilute hydrochloric acid.

- a) Write an equation for the reaction.
- b) Name an appropriate drying agent for hydrogen gas.
- c) Explain why copper metal cannot be used to prepare hydrogen gas.
- d) Hydrogen burns in oxygen to form an oxide.
 - (i) Write an equation for the reaction.
 - (ii) State **two** precautions that must be taken before the combustion begins and at the end of the combustion.
- e) Give **two** uses of hydrogen gas.
- f) When zinc is heated to redness in a current of steam, hydrogen gas is obtained. Write an equation for the reaction.
- g) Element **Q** reacts with dilute acids but not with cold water. Element **R** does not react with



dilute acids. Element **S** displaces element **P** from its oxide. **P** reacts with cold water. Arrange

the four elements in order of their reactivity, starting with the most reactive.

h) Explain how hydrogen is used in the manufacture of margarine.

10. a) The set-up below is used to investigate the properties of hydrogen.

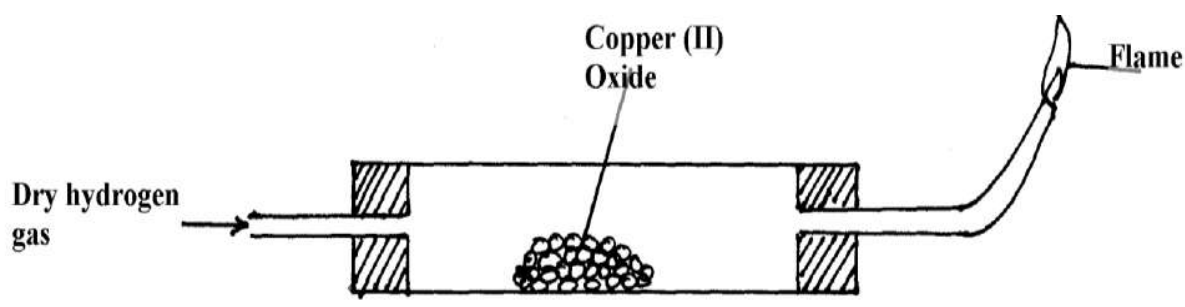

i) On the diagram, indicate what should be done for the reaction to occur

ii) Hydrogen gas is allowed to pass through the tube for some time before it is lit. Explain

iii) Write an equation for the reaction that occurs in the combustion tube

iv) When the reaction is complete, hydrogen gas is passed through the apparatus until they

cool down . Explain

v) What property of hydrogen is being investigated?

vi) What observation confirms the property stated in (v) above?

vii) Why is zinc oxide not used to investigate this property of hydrogen gas?

11. The set up below was used to collect gas **K**, produced by the reaction between water and

calcium metal.

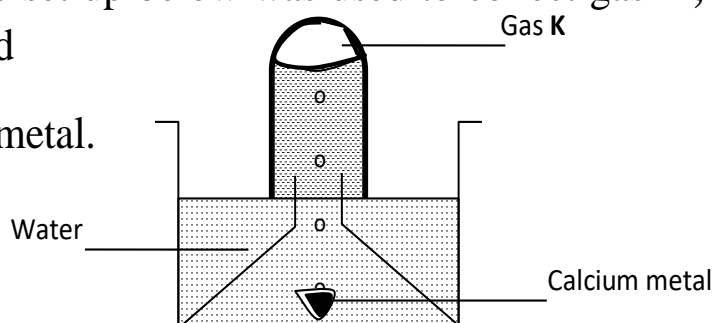

(a) Name gas **K**

(b) At the end of the experiment, the solution in the beaker was found to be a weak base. Explain

why the solution is a weak base



FOR: Form 2, 3 & 4 NOTES, latest & Updated Schemes of Work, Quality Revision Booklets, Entry, Mid-Term & End-Term Exams, All KASNEB notes, Set-Books Acted Videos.....

WhatsApp Sir Obiero Amos @ 0706 851 439

